

Letter from the Program Chair

Welcome to the 70th Annual Meeting of the Evangelical Theological Society

Over the last few years there has been a renewed discussion in evangelical circles about the nature of God, particularly as our Triune Lord. Thus, it is fitting that the theme of the 70th meeting of the Evangelical Theological Society is “Holy Spirit.” While questions about the person and work of the Holy Spirit have certainly occasioned much debate amongst Christians over the years, it is our hope that this theme might also provide an opportunity to remember what unites us. After all, the apostle Paul reminds us, “There is one body and one Spirit···one Lord, one faith, one baptism, one God and father of all” (Eph 4:4-6).

Given the potential breadth of this year’s theme, the meeting has been designed to explore the Holy Spirit from multiple angles. Most naturally, of course, this theme will be studied from a theological perspective. But, we hope it will also be studied from a historical/ecclesiastical perspective, as well as from an exegetical/biblical one. All three together will enrich our appreciation and understanding of this vital topic.

The plenary speakers have been chosen to reflect each of these perspectives on the theme. Addressing the Holy Spirit theologically is Michael Horton, J. Gresham Machen Professor of Systematic Theology and Apologetics at Westminster Seminary in California, and author of numerous theological works including *Rediscovering the Holy Spirit* (2017). Addressing the Holy Spirit historically is Michael Haykin, Professor of Church History and Biblical Spirituality at the Southern Baptist Theological Seminary, and author of numerous works in church history including *Empire of the Holy Spirit* (2010). Addressing the Holy Spirit exegetically is Craig Keener, the F.M. and Ada Thompson Professor of Biblical Studies at Asbury Theological Seminary, and author of numerous commentaries including the massive four-volume series on Acts with Baker Academic (2012-2015).

Of course, as always, the conference will include several hundred papers on other important topics beyond the main theme. We trust you will enjoy these papers as well as the deep conversations and rich fellowship that will hopefully follow.

Let me also ask you to join me in thanking all those who labored to make this conference possible, especially the Executive Committee, program committees, and other volunteers. A special thanks should also go to the Executive Director, Michael Thigpen, and the Meeting Planner, Bonnie Thigpen, for their tireless efforts to plan and execute this conference.

Look forward to seeing you in Denver!

Sincerely,
Michael J. Kruger
ETS President-Elect and Program Chair
President and Professor of New Testament,
Reformed Theological Seminary, Charlotte, NC

General Conference Information

Conference Location

The 70th Annual Meeting will take place at the Sheraton Denver Downtown in Denver, CO. Discounted group rates are available. To see rate information and reservation instructions please go to http://www.etsjets.org/hotel_information.

Future Meetings

2019: Christ in all Scripture – November 19 - 21 in San Diego, CA

2020: Christianity and Islam – November 17 - 19 in Providence, RI

Conference Registration

Pre-registration is available at www.etsjets.org/registration_landing through October 15, 2018. This page includes complete details on pricing, key deadlines, and how to register online. Please use the form in the back of the program to register by mail. If you need assistance or have questions about conference registration, please email meeting@etsjets.org.

On-site registration will be available at the Conference Registration desk located on the Concourse Level in the Plaza Building of the Sheraton.

Banquet tickets can be purchased with pre-registrations or onsite (while available) at the registration desk for \$20. Subsidized by ETS, this three course, \$50 meal, will be followed by Dr. David S. Dockery's presidential address.

Conference Registration Desk

The Conference Registration Desk is located on the Concourse Level in the Plaza Building of the Sheraton.

Registration Desk Hours:

Monday, November 12:	6:00 PM - 9:00 PM
Tuesday, November 13:	7:00 AM - 5:00 PM
Wednesday, November 14:	7:00 AM - 5:00 PM
Thursday, November 15:	8:00 AM - 1:00 PM

The Exhibit Hall

The Exhibit Hall is located on the Concourse Level of the Plaza Building of the Sheraton. With more than 50 confirmed exhibitors, this year promises to be exceptional. Most exhibitors offer generous discounts on their products making this an excellent opportunity to gain valuable resources. Conference name badges must be worn to gain entrance to the Exhibit Hall. There are no exceptions to this policy.

Exhibit Hall Hours:

Tuesday, November 13:	8:30 AM - 6:00 PM
Wednesday, November 14:	8:30 AM - 6:00 PM
Thursday, November 15:	8:30 AM - 2:00 PM

A floor plan of the exhibit hall and listing of exhibitors may be found in the back of the program and in the program app.

Online Program

The program is available online at www.etsjets.org/annual_program

General Conference Information

Program App

Download the ETS Program App onto your iPhone or Smartphone for access to the program, maps, list of exhibitors, advertisements, special events, and more. The program app is updated immediately with each change in the program so you will never get caught at a cancelled session when using the app.

- View the daily schedule
- Add sessions to your personal schedule
- Search the app for people, topics, and sessions

Search for ETS 2018 in the App Store™ or Google Play™.

Parallel sessions

The parallel sessions are composed of five different session types.

P Program Unit Sessions

are a combination of invited papers and proposed presentations which were selected by the program unit steering committees. ETS has three types of program units. Consultations are new program units which are responsible for one session of invited papers at the meeting. Study Groups are narrowly focused groups which require active, collaborative participation by the group members. ETS encourages study groups to publish the results of their work. Study groups are responsible for one session of invited papers at the annual meeting. Sections are broadly defined groups that represent general areas of interest. Responsible for one session of invited papers and one session of papers drawn from member submissions, the sections offer the most access for unsolicited papers.

A Affiliated Society Sessions

feature presentations that were selected and arranged by one of the three societies which join ETS each year: the Evangelical Philosophical Society, the Near East Archaeological Society, and the Adventist Theological Society.

D Discipline Specific Sessions

are composed of presentations that were submitted by ETS members and rated by a panel of scholars who served under the direction of the program chair. These presentations have been grouped into basic disciplines: Old Testament, New Testament, Systematic Theology, Church History/Historical Theology, and Practical Theology.

T Theme Sessions

are composed of presentations submitted by members, which address the conference theme. These presentations were evaluated by a panel of scholars under the direction of the program chair. The theme presentations have been arranged into cohesive sessions based on texts, topics, and methods.

C Career Sessions

are special sessions that are designed to help ETS members in their careers. These sessions include discussions of the academic job market, publishing, interviewing, and other significant career development topics.

Plenary Speakers



Michael A. G. Haykin

The Southern Baptist
Theological Seminary

*"Not by might, nor by
power, but by my Spirit":
The Holy Spirit & Human
Experience in the Long 18th
Century*



Craig S. Keener

Asbury Theological Seminary

*The Spirit and the Mission
of the Church*



Michael Horton

Westminster Seminary
California

*Lord and Life-Giver: The
Holy Spirit's Role in the
History of Redemption*

ETS Executive Committee

President

David S. Dockery
Trinity International University

President-Elect / Program Chair

Michael J. Kruger
Reformed Theology Seminary

Vice-President

Craig S. Keener
Asbury Theological Seminary

Secretary

Gregg R. Allison
The Southern Baptist Theological Seminary

Past Presidents

Thomas R. Schreiner (2014)
The Southern Baptist Theological Seminary

Scott B. Rae (2015)
Talbot School of Theology

Daniel B. Wallace (2016)
Dallas Theological Seminary /
Center for the Study of New Testament Manuscripts

Sam Storms (2017)
Bridgeway Church / Enjoying God Ministries

Executive Director

J. Michael Thigpen
Talbot School of Theology

Special Events

Tuesday, November 13th

Lunch

12:15 PM - 1:45 PM

Luncheon for the 2018 ETS Scholarship
Recipients

Plaza Building - Concourse Level - Governor's
Square 9

Evening

7:00 PM - 9:00 PM

2018 ETS Alumni Connect Reception
Gordon-Conwell Theological Seminary

Plaza Building - Concourse Level - Plaza Court 6

8:30 PM - 10:30 PM

Evangelical Philosophical Society Reception
Tower Building - 2nd Floor - Windows

9:15 PM - 10:45 PM

Networking for Chinese Evangelical Theological
Fellowship

Plaza Building - Lobby Level - Director's Row F

Wednesday, November 14th

Breakfast

6:45 AM - 8:15 AM

Dallas Theological Seminary Alumni Breakfast

Tower Building - 2nd Floor - Grand Ballroom I

Lunch

11:45 AM - 12:45 PM

Ratio Christi Lunch for Professors

Plaza Building - Lobby Level - Director's Row I

11:45 AM - 12:45 PM

An Exegetical and Intertextual Exploration of
the Presence of the Spirit in the Colossians
Tutku - Educational Travel

Plaza Building - Lobby Level - Director's Row H

Wednesday, November 14th

Evening

9:15 PM - 10:30 PM

Dessert with the Authors of Marriage
Moody Publishers

Tower Building - 2nd Floor - Tower Court A

9:15 PM - 12:00 AM

Southern Seminary Late Night

The Southern Baptist Theological Seminary

Tower Building - 2nd Floor - Grand Ballroom I

9:15 PM - 11:00 PM

Talbot School of Theology Alumni Dessert

Plaza Building - Lobby Level - Director's Row I

9:15 PM - 11:30 PM

Trinity Evangelical Divinity School Alumni
Reception

Tower Building - 2nd Floor - Windows

Thursday, November 15th

Breakfast

6:00 AM - 8:00 AM

ETS Program Unit Chairs' Breakfast

Plaza Building - Concourse Level - Governor's
Square 14

7:00 AM - 9:00 AM

Jerusalem University College Associated School
Breakfast

Plaza Building - Lobby Level - Director's Row E

7:30 AM - 8:15 AM

Denver Seminary Welcome Home Breakfast

Plaza Building - Lobby Level - Director's Row J

Frequently Asked Questions

If I pre-registered, when will I receive my name badge?

All name badges and banquet tickets will be mailed by October 31st. If you do not receive your name badge in the mail you can print a replacement badge at the Conference Registration desk.

Can I replace my name badge if I never received it in the mail, forgot to bring it, or have lost it?

Yes, go to the Name Badge Reprint station at the Conference Registration Desk to print a replacement badge.

I didn't purchase a banquet ticket when I registered, can I still get one?

Tickets can be purchased at the Conference Registration desk until 6pm on Tuesday, November 13th.

Where is the Conference Registration desk?

The Conference Registration desk is located on the Concourse Level in the Plaza Tower of the Sheraton. Please see page 2 for the Conference Registration desk hours.

Where are the books?

The Exhibit Hall is located on the Concourse Level in the Plaza Tower of the Sheraton. Please see page 2 for the exhibit hall hours. There is a list of exhibitors and map of the exhibit hall in the back of the program.

Do I have to have my name badge to go in the exhibit hall?

Yes. No one will be granted admission to the exhibit hall without a name badge.

I'm looking for a teaching position. Where would I find the current job postings?

Job postings are listed on the ETS website at www.etsjets.org/employment/overview.

How can our institution post our current job openings?

Jobs may be posted on the ETS website by emailing the posting information to: contact@etsjets.org.

How can I get a copy of a presentation?

ETS does not collect the individual presentations. To obtain a copy, you can request one from the speaker. Presentation recordings may be purchased from WordMp3 (Booth 107) in the exhibit hall or from their website at www.wordmp3.com.

What is the conference refund policy?

Registration and banquet tickets are fully refundable until October 20, 2018. To request a refund please go to www.etsjets.org/refund_request_landing

I'm not a member of ETS, but would like to become one. Can I apply for membership at the conference?

Yes. Although it's best to apply for membership before the conference, you can submit a membership application at the Conference Registration desk. The application can be found in the back of the program.

I'm not a member of ETS, but would like to receive JETS. How can I subscribe?

You can subscribe via our website at www.etsjets.org/subscription_landing, or you can complete the subscription form in the back of the program and turn it in at the Conference Registration desk.

Can I get free WiFi in the Sheraton?

There is free WiFi in the Sheraton lobby, but not in the meeting rooms or exhibit hall.

Schedule Overview

Tuesday, November 13th

8:15 AM - 8:45 AM Morning Prayer

Parallel Sessions A

9:00 AM - 9:40 AM Parallel Session

9:50 AM - 10:30 AM Parallel Session

10:40 AM - 11:20 AM Parallel Session

11:30 AM - 12:10 PM Parallel Session

12:15 pm - 1:45 pm Lunch

Parallel Sessions B

2:00 PM - 2:40 PM Parallel Session

2:50 PM - 3:30 PM Parallel Session

3:40 PM - 4:20 PM Parallel Session

4:30 PM - 5:10 PM Parallel Session

Plenary Session I

5:25 PM - 6:15 PM Michael A. G. Haykin

Wednesday, November 14th

7:45 AM - 8:15 AM Morning Prayer

Parallel Sessions C

8:30 AM - 9:10 AM Parallel Session

9:20 AM - 10:00 AM Parallel Session

10:10 AM - 10:50 AM Parallel Session

11:00 AM - 11:40 AM Parallel Session

11:45 AM - 12:45 PM Lunch

11:45 am - 12:15 pm NEAS Member Meeting

Plenary Session II

1:00 PM - 1:50 PM Craig S. Keener

EPS Plenary Session

2:00 PM - 2:50 PM William Lane Craig

Parallel Sessions D

3:00 PM - 3:40 PM Parallel Session

3:50 PM - 4:30 PM Parallel Session

4:40 PM - 5:20 PM Parallel Session

5:30 PM - 6:10 PM Parallel Session

7:00 pm - 8:00 pm Banquet

8:00 pm - 9:00 pm Presidential Address -
David S. Dockery

Thursday, November 15

7:45 AM - 8:15 AM Morning Prayer

Plenary Session II

8:30 AM - 9:20 AM Michael Horton

9:30 AM - 10:00 AM Corporate Worship

10:15 AM - 11:15 AM ETS Business Meeting

10:15 AM - 11:15 AM EPS Business Meeting

11:15 am - 12:45 pm Lunch

Parallel Sessions E

1:00 PM - 1:40 PM Parallel Session

1:50 PM - 2:30 PM Parallel Session

2:40 PM - 3:20 PM Parallel Session

3:30 PM - 4:10 PM Parallel Session

Parallel Session A Overview

Session Title	Location
American Christianity – Review of <i>Believe Me: The Evangelical Road to Donald Trump</i>	Silver
Biblical Theology	Governor’s Square 16
Evangelicals and Gender – Gender in Biblical Perspective	Plaza Court 6
Johannine Literature – Unity and Diversity	Denver
Old Testament Backgrounds / Ancient Near East – Comparative Methodology	Plaza Court 8
Synoptic Gospels	Gold
Theology for Counseling and Pastoral Care – Union with Christ, Sanctification, & Psychotherapy	Governor’s Square 12
Evangelical Philosophical Society A1	Tower Court B
Evangelical Philosophical Society A2	Tower Court C
Evangelical Philosophical Society A3	Tower Court D
Near East Archaeological Society A – General Biblical Archaeology	Governor’s Square 17
Holy Spirit - Church History – 18th-19th Century	Terrace
Holy Spirit - Church History – General Studies	Biltmore
Holy Spirit - New Testament – General Studies	Century
Holy Spirit - New Testament – Pauline Literature 1	Windows
Holy Spirit - New Testament – Pauline Literature 2	Spruce
Holy Spirit - Old Testament – General Studies 1	Vail
Holy Spirit - Practical Theology – General Studies 1	Director’s Row E
Holy Spirit - Systematic Theology – Biblical Theology	Grand Ballroom I
Holy Spirit - Systematic Theology – Contemporary Evangelicalism and Mission	Governor’s Square 11
Holy Spirit - Systematic Theology – Hermeneutics	Governor’s Square 10
Church History – Church Fathers	Columbine
Church History – Medieval Era	Beverly
Exploring 18th Century Evangelicalism: A Survey of Piety and Theology	Colorado
New Testament – Acts	Tower Court A
Old Testament – General Studies	Capitol
Old Testament – Isaiah and Jeremiah	Savoy
Old Testament – Pentateuch 1	Plaza Court 7
Old Testament – Psalms	Majestic Ballroom
Perspectives on the Spiritual Gifts	Governor’s Square 14
Practical Theology – General Studies 1	Grand Ballroom II
Systematic Theology – Biblical Theology	Director’s Row I
Systematic Theology – Christology	Director’s Row J
Systematic Theology – Social Justice and Ecclesiology	Director’s Row H
Systematic Theology – Theology Proper and Impassibility	Governor’s Square 15

Parallel Session B Overview

Session Title	Location
Biblical Theology – The State of Biblical Theology in the Twenty-First Century	Grand Ballroom I
Christian Ethics	Plaza Court 7
Christianity and Culture – Cultural Conflicts	Director's Row J
Creation	Terrace
Evangelicals and Gender – Sexual Abuse, Gender and Power	Governor's Square 14
Hermeneutics	Governor's Square 16
Luke / Acts	Tower Court A
Method in Systematic Theology – Theological Method	Director's Row E
NT Greek Language and Exegesis – The Letter to the Romans: Exegesis and Implications	Vail
Old Testament Narrative Literature	Columbine
Old Testament Theology – Legacy of Willem VanGemeren for Old Testament Theology	Majestic Ballroom
Patristic and Medieval History – Blessedness and Grace, Buildings and Manuscripts	Plaza Court 6
Psalms and Hebrew Poetry	Beverly
Synoptic Gospels	Savoy
Theology for Counseling and Pastoral Care – Union with Christ, Sanctification, & Psychotherapy	Silver
Evangelical Philosophical Society B1	Tower Court B
Evangelical Philosophical Society B2	Tower Court C
Evangelical Philosophical Society B3	Tower Court D
Near East Archaeological Society B – Challenging Generally Accepted Archaeological Paradigms	Governor's Square 17
Holy Spirit - Church History – 17th-18th Century England	Governor's Square 11
Holy Spirit - Church History - Patristic and Medieval Era	Director's Row I
Holy Spirit - New Testament - Pauline Literature 3	Windows
Holy Spirit - Practical Theology - Homiletics	Spruce
Holy Spirit - Systematic Theology - General Studies 1	Gold
Holy Spirit - Systematic Theology - General Studies 2	Plaza Court 8
Holy Spirit - Systematic Theology - The Trinity	Century
Church History - General Studies	Governor's Square 15
Church History - Luther and Calvin	Governor's Square 10
New Testament - Johannine Literature	Colorado
New Testament - Matthew	Denver
New Testament - Synoptics	Biltmore
Old Testament - Minor Prophets and Daniel	Capitol
Practical Theology - Beauty	Director's Row H
Retrieving Eternal Procession	Governor's Square 12
The Nashville Statement: Promise or Problem for Evangelical Sexual Ethics?	Grand Ballroom II

Parallel Session C Overview

Session	Location
American Christianity	Tower Court A
Asian/Asian-American Theology – Asian Pneumatology in the Context of Asian-American Church	Terrace
Baptist Studies – Baptists and the Holy Spirit	Century
Biblical Worship	Beverly
Bioethics – Theological Anthropology in Bioethics	Gold
Christian History and Thought since 1700 – The Oxford Movement and Evangelicalism	Spruce
Ecclesiology – Ecclesiological Contextualization in North America	Biltmore
Expository Preaching and Hermeneutics – The Spirit's Distinctive Ministry	Silver
General Epistles – Typology in the Book of Hebrews	Capitol
Hebrew Language – Teaching Intermediate Hebrew and Hebrew Exegesis	Governor's Square 9
Method in Systematic Theology – Exploring Kärkkäinen's Project	Columbine
New Testament Greek Language and Exegesis	Governor's Square 12
Old Testament Backgrounds / Ancient Near East – Cultic Law	Governor's Square 14
Old Testament Prophetic and Apocalyptic Books – Zephaniah - Malachi	Governor's Square 11
Pastoral Epistles	Savoy
Paul's Letter to the Romans – The Gospel, Sin, and Salvation	Majestic Ballroom
Pentateuch – Kingship in the Pentateuch	Governor's Square 16
Reformation Studies – A Symposium on the 400th Anniversary of Dort	Denver
Spiritual Formation / Sanctification – Spiritual Formation, Spirit & Virtue	Vail
Wesleyan Studies – Sanctification	Colorado
Evangelical Philosophical Society C1	Tower Court B
Evangelical Philosophical Society C2	Tower Court C
Evangelical Philosophical Society C3 – The Parting of the Holy Spirit from the West	Tower Court D
Near East Archaeological Society C – Season Site Reports and Excavation Results, Part 1	Governor's Square 17
Holy Spirit - Old Testament – General Studies 2	Plaza Court 6
Holy Spirit - Systematic Theology – Evangelism and Apologetics	Plaza Court 8
The Holy Spirit, the Power of God, and the Future of Evangelical Theology	Plaza Ballroom
Church History – 17th-18th Century	Plaza Court 7
New Testament – Pauline Literature 1	Director's Row E
Practical Theology – Pastoral Leadership	Governor's Square 10
Systematic Theology – Anthropology	Governor's Square 15
Systematic Theology – General Studies 1	Windows
Mini-Workshop for Early-Career Faculty on Assessing Teaching and Learning	Director's Row J

Parallel Session D Overview

Session	Location
Applied Linguistics and Biblical Languages – Facilitating Learning Outside the Classroom	Capitol
Biblical Worship	Director's Row J
Bioethics	Plaza Court 6
Christian History and Thought since 1700 – The Oxford Movement and Evangelicalism	Governor's Square 16
Christianity and Culture – A Conversation with Philip Yancey	Grand Ballroom II
Hermeneutics – The Role of the Holy Spirit in Christian Interpretation of Scripture	Governor's Square 12
Inerrancy of Scripture – Inerrancy in the Life of the Church	Governor's Square 14
Islam & Evangelical Christianity – Religious Liberty	Governor's Square 15
Letter to the Hebrews – Currents and Rapids in Hebrews' Scholarship	Century
New Testament Canon, Textual Criticism & Apocryphal Literature	Silver
Old Testament Narrative Literature – Narrative Criticism	Columbine
Old Testament Theology – Canon and Canonical Reading	Plaza Court 7
Patristic and Medieval History – The Holy Spirit in Patristic Thought	Tower Court A
Pauline Studies – Scripture in Romans & 1 Corinthians	Gold
Pentateuch	Director's Row H
Psalms and Hebrew Poetry – Canonical Studies in the Psalms after Thirty Years	Terrace
Reformation Studies – Dort and Westminster (1618-1648)	Spruce
Septuagint Studies	Denver
Spiritual Formation / Sanctification – Spiritual Formation and Holy Spirit	Vail
Voice in American Theology and Culture – Holy People, Holy Land	Plaza Court 8
Adventist Theological Society I	Director's Row I
Evangelical Philosophical Society D1	Tower Court B
Evangelical Philosophical Society D2	Tower Court C
Evangelical Philosophical Society D3	Tower Court D
Near East Archaeological Society D – Season Site Reports and Excavation Results, Part 2	Governor's Square 17
Holy Spirit - Systematic Theology – Sanctification	Director's Row E
Reflections on <i>Rediscovering the Holy Spirit</i> and the Future of Pneumatology in Dogmatics	Windows
Church History – 19th-20th Century	Governor's Square 9
New Testament – Pauline Literature 2	Colorado
Old Testament – Historical Books	Savoy
Practical Theology – Care and Counseling	Governor's Square 11
Practical Theology – General Studies 2	Biltmore
Progressive Covenantalism	Beverly
Systematic Theology – General Studies 3	Governor's Square 10
The Creation Project	Majestic Ballroom

Parallel Session E Overview

Session	Location
Analytic Theology – Salvation by Allegiance Alone?	Terrace
Anglican Theology – Confessions, Creeds, and Reformed Catholicity	Gold
Christian Ethics – Redeeming Liberalism?: Christianity and the Future of Liberal Politics	Director's Row J
Greco-Roman Backgrounds – Adoption in the Greco-Roman World	Capitol
Johannine Literature	Savoy
Luke / Acts – Contemporary Reflections on the Holy Spirit in Acts	Biltmore
Messianic Jewish Studies – Jewish-Christian Dialogue: from Antiquity to Today	Governor's Square 9
Models of God – The God of Jonathan Edwards 4	Tower Court A
New Testament Canon, Textual Criticism & Apocryphal Literature – The Holy Spirit	Vail
Old Testament Prophetic and Apocalyptic Books – Zephaniah, Haggai, Zechariah, and Malachi	Governor's Square 16
Old Testament Wisdom Literature – The Wisdom of Metaphor	Plaza Court 8
Pauline Studies	Denver
Public Theology – Holy Spirit Justice	Plaza Court 6
The Book of Revelation – The Holy Spirit in the Book of Revelation	Beverly
Theological Education and Pedagogy – What I've Learned as an Educator and Leader	Grand Ballroom II
Trinitarian Theology – Reflecting on the Relational Trinity	Century
Warfare and Violence in the Old Testament – Conquest and Divine Violence	Plaza Court 7
Adventist Theological Society II	Director's Row I
Evangelical Philosophical Society E1	Tower Court B
Evangelical Philosophical Society E2	Tower Court C
Evangelical Philosophical Society E3	Tower Court D
Near East Archaeological Society E – General Biblical Archaeology	Governor's Square 17
Holy Spirit - Church History – 20th-21st Century	Director's Row E
Holy Spirit - Practical Theology – General Studies 2	Silver
Holy Spirit - Systematic Theology – Anthropology and Ecclesiology	Governor's Square 14
Holy Spirit - Systematic Theology – General Studies 3	Governor's Square 11
Holy Spirit - Systematic Theology – Soteriology	Governor's Square 12
Church History – Baptist and Puritan Theology	Colorado
Church History – Edwards	Windows
Karl Barth, the Holy Spirit, and Pentecostal Systematic Theology	Spruce
New Testament – General Studies	Columbine
New Testament – Pauline Literature 3	Director's Row H
Old Testament – OT Theology and Hermeneutics	Governor's Square 15
Old Testament – Pentateuch 2	Governor's Square 10
Systematic Theology – General Studies 2	Grand Ballroom I
Systematic Theology – Social Justice and Reconciliation	Majestic Ballroom

Tuesday, November 13 9:00 AM – 12:10 PM

8:15 AM - 8:45 AM

Morning Prayer

Join us for a simple worship service of scripture and prayer

P 9:00 AM-12:10 PM

American Christianity

A Review Session of Believe Me: The Evangelical Road to Donald Trump by John Fea

Tower Building – Mezzanine Level Silver

Moderator: Miles S. Mullin II
(Hannibal-LaGrange University)

9:00 AM—9:15 AM

Miles S. Mullin II

(Hannibal-LaGrange University)

Introduction of the book and the presenters

9:15 AM—9:45 AM

Justin Taylor

(Crossway)

9:50 AM—10:20 AM

Gary Steward

(Colorado Christian University)

10:25 AM—10:55 AM

Jemar Tisby

(University of Mississippi)

11:00 AM—11:20 AM

Respondent: John Fea*

(Messiah College)

11:25 AM—12:10 PM

Panel and Audience Discussion

P 9:00 AM-12:10 PM

Biblical Theology

Plaza Building – Concourse Level

Governor's Square 16

Moderator: James M. Hamilton Jr.

(Southern Baptist Theological Seminary)

9:00 AM—9:40 AM

Trevor Laurence

(University of Exeter)

Serpent Seed and Son of God: The Enemy and Imprecator in the Psalms of Vengeance

9:50 AM—10:30 AM

Andy Naselli

(Bethlehem College & Seminary)

Kill the Dragon, Get the Girl: A Biblical Theology of Snakes and Dragons

10:40 AM—11:20 AM

David S. Schrock

(Indianapolis Theological Seminary)

A Family of Royal Priests: Why the Priesthood of Believers Must Be "In Christ"

11:30 AM—12:10 PM

Max Rogland

(Erskine Theological Seminary)

Esther: Type of Christ, Type of the Church, or No Type At All?

P 9:00 AM-12:10 PM

Evangelicals and Gender

Gender in Biblical Perspective

Plaza Building – Concourse Level

Plaza Court 6

Moderators:

Cynthia Long Westfall

(McMaster Divinity College)

Gerry Breshears

(Western Seminary)

9:00 AM—9:40 AM

Mary L. Conway

(McMaster Divinity College)

Gender in Genesis 1 – 3 in

Conversation with 1 Timothy 2

9:50 AM—10:30 AM

David E. Malick

(Independent Expositor)

Narrative Structure, Characterization, and Women in Mark 15:40-41

10:40 AM—11:20 AM

Timothy Paul Erdel

(Bethel College)

Exploring the Garden of Feminine Motifs in Song of Songs

11:30 AM—12:10 PM

Andy Draycott

(Talbot School of Theology, Biola University)

Walking across Gender in the Spirit? The Vocation of the Church and the Transgender Christian

P 9:00 AM-12:10 PM

Johannine Literature

Unity and Diversity: Connections between the Fourth Gospel and Revelation

Tower Building – Mezzanine Level Denver

Moderators:

Robert W. Yarbrough

(Covenant Theological Seminary)

Edward W. Klink III

(Hope Church)

*Invited Guest of ETS

Tuesday, November 13th 9:00 AM – 12:10 PM

Stanley E. Porter
(McMaster Divinity College)

9:00 AM—9:40 AM

Stanley E. Porter
(McMaster Divinity College)

The Language(s) of John's Gospel and Revelation: What Do the Similarities and Differences Tell Us?

9:50 AM—10:30 AM

Dana M. Harris
(Trinity Evangelical Divinity School)
The Spirit in the Fourth Gospel and the Book of Revelation

10:40 AM—11:20 AM

Douglas Estes
(South University, Columbia)
Imagination in Johannine Thought: From the Fourth Gospel to Revelation

11:30 AM—12:10 PM

Mark Wilson
(Stellenbosch University)
A Spring of Living Water: Metaphors for Spirit in the Fourth Gospel and Revelation

P 9:00 AM-12:10 PM

Old Testament Backgrounds / Ancient Near East Comparative Methodology

Plaza Building – Concourse Level
Plaza Court 8

Moderator: Matthew McAfee
(Welch College)

9:00 AM—9:40 AM

Kenton F. Williams
(Trinity Evangelical Divinity School)
A King's Speech: Royal Ideology in 1 Sam 17:31-37

9:50 AM—10:30 AM

Matthew McAfee
(Welch College)
Lexicography and the Comparative Method: Some Methodological Considerations

10:40 AM—11:20 AM

Stephen J. Andrews
(Midwestern Baptist Theological Seminary)
The Ketef Hinnom Inscriptions and the Existence of Apotropaic Texts in the Hebrew Bible

11:30 AM—12:10 PM

Jordan W. Jones
(Hebrew Union College - Jewish Institute of Religion)
The Outstretched Hand of Lady Wisdom in Prov 1:24 and Analogous Texts from the Ancient Near East

P 9:00 AM-12:10 PM

Synoptic Gospels

Tower Building – Mezzanine Level
Gold

Moderator: Michael H. Burer
(Dallas Theological Seminary)

9:00 AM—9:40 AM

John Lee
(Midwestern Baptist Theological Seminary)
The Synoptic Jesus Exclusively as an Idealized Human Figure? A Response to Kirk's Proposal

9:50 AM—10:30 AM

Zachary K. Dawson
(McMaster Divinity College)
Gospels and Genre Theory: Detailing the Problems in Gospel Research and a Way Forward

10:40 AM—11:20 AM

Michael Licona
(Houston Baptist University)
What do We Mean by the Term "Historically Reliable"? A Proposal of Definition and Criteria

11:30 AM—12:10 PM

Ji Hoe Kim
(McMaster Divinity College)
Hallidayan Approach to Orality and Textuality and its Implications for Synoptic Gospel Studies

P 9:00 AM-12:10 PM

Theology for Counseling and Pastoral Care

Union with Christ, Sanctification, & Psychotherapy: Reflections on Eric L. Johnson's *God and Soul Care* (IVP, 2017)

Plaza Building – Concourse Level
Governor's Square 12

Moderator: Stephen P. Greggo
(Trinity Evangelical Divinity School)

9:00 AM—9:40 AM

Steven L. Porter
(Biola University)
A Theological Review of Union with Christ in *God & Soul Care*

9:40 AM—10:20 AM

Keith Palmer*
(Grace Bible Church)
Biblical Counseling Perspectives on *God & Soul Care*

10:30 AM—11:10 AM

Fred Gingrich*
(Denver Seminary)
Integration Perspectives on *God & Soul Care*

*Invited Guest of ETS

Tuesday, November 13 9:00 AM – 12:10 PM

11:10 AM—11:35 AM

Eric L. Johnson
(Southern Baptist Theological Seminary)
God & Soul Care: The Therapeutic Resources of the Christian Faith (IVP, 2017)

11:35 AM—12:10 PM

Panel Discussion

A 9:00 AM-12:10 PM

Evangelical Philosophical Society A1

Tower Building – 2nd Floor
Tower Court B

Moderator: Randy Everist
(University of Birmingham)

9:00 AM—9:40 AM

Angus J.L. Menuge
(Concordia University Wisconsin)
Vindicating the Dilemma for Evolutionary Ethics: A Response to Erik Wielenberg

9:50 AM—10:30 AM

Chris D. Lee
(Southwestern Baptist Theological Seminary)
A Lewis – Plantinga Response to Epistemic Skepticism Regarding Religious Experience

10:40 AM—11:20 AM

W. Paul Franks
(Tyndale University College)
Moral Arguments, Objectivity, and Obligation

11:30 AM—12:10 PM

Michael W. Austin
(Eastern Kentucky University)
Hursthous, Humility, and Human Flourishing

A 9:00 AM-12:10 PM

Evangelical Philosophical Society A2

Tower Building – 2nd Floor
Tower Court C

Moderator: Brandon Rickabaugh
(Baylor University)

9:00 AM—9:40 AM

Travis Dickinson
(Southwestern Baptist Theological Seminary)
An Evidentialist Model of Faith

9:50 AM—10:30 AM

Liz Jackson
(University of Notre Dame)
Epistemic Permissivism and Pascal's Wager

10:40 AM—11:20 AM

James Elliott
(Purdue University)
On the Incompatibility of Faith and Intellectual Humility

11:30 AM—12:10 PM

David E. Alexander
(Huntington University)
Anthony Bryson
(Arizona Christian University)
The Harmony of Christian Belief and Epistemic Internalism

A 9:00 AM-12:10 PM

Evangelical Philosophical Society A3

Tower Building – 2nd Floor
Tower Court D

Moderator: Tim Hsiao
(Grantham University)

9:00 AM—9:40 AM

Kirk R. MacGregor
(McPherson College)
In Defense of Molina's Doctrine of Supercomprehension

9:50 AM—10:30 AM

Douglas Groothuis
(Denver Seminary)
Lament as Christian Apologetic

10:40 AM—11:20 AM

Clay Jones
(Biola University)
How Immortality Projects and Mortality Mitigation Projects Fail

11:30 AM—12:10 PM

James S. Spiegel
(Taylor University)
The Virtue of Open-Mindedness: Benefits and Risks

A 9:00 AM-12:10 PM

Near East Archaeological Society A

General Biblical Archaeology
Plaza Building – Concourse Level
Governor's Square 17

Moderator: Donald McNeeley
(Tidewater Bible College)

9:00 AM—9:40 AM

Ralph Hawkins
(Averett University)
Khirbet 'Auja el-Foqa and the Manasseh-Ephraim Boundary Description (Josh 16:6-7)

9:50 AM—10:30 AM

John Wineland
(Southeastern University)
Archaeological Surveys on the Karak Plateau: Evidence for Nabateans

Tuesday, November 13th 9:00 AM – 12:10 PM

10:40 AM—11:20 AM

Boyd SeEVERS

(University of Northwestern – St. Paul)

Victoria DENNIS

(University of Northwestern – St. Paul)

Slinging in the Biblical World:

Methods, Capabilities, and
Ammunition

11:30 AM—12:10 PM

Mark A. Hassler

(Virginia Beach Theological Seminary)

Katherine A. Streckert

(University of Northwestern—St. Paul)

The Early Roman Weapons and
Northern Fortification Tower at Kh.
el-Maqatir: A Preliminary Report

T 9:00 AM-12:10 PM

Holy Spirit - Church History

18th-19th Century

Tower Building – Terrace Level

Terrace

Moderator: William T. Chandler

(Rock Haven Baptist Church)

9:00 AM—9:40 AM

Michael D. McMullen

(Midwestern Baptist Theological
Seminary)

The Doctrine of the Holy Spirit in the
Life and Unpublished Writings of
William Wilberforce

9:50 AM—10:30 AM

Matthew Rowley

(McMaster Divinity College)

Early Evangelical Pneumatology in
the Sermons of George Whitefield

10:40 AM—11:20 AM

Randall J. Gruendyke

(Grace Evangelical Free Church, La
Mirada, CA)

Charles Simeon and the Holy Spirit: A
Biblical Middle in an Age of Extremes

11:30 AM—12:10 PM

Justin McLendon

(Grand Canyon University)

Herman Bavinck and Church

Discipline: Exploring the Visibility of
the Spirit's Ruling Power

T 9:00 AM-12:10 PM

Holy Spirit - Church History

General Studies

Tower Building – Terrace Level

Biltmore

Moderator: Nathan Tarr

(Christ Baptist Church)

9:00 AM—9:40 AM

Nathan Tarr

(Christ Baptist Church)

"The Elegancy of the Holy Ghost":

The Holy Spirit and Aesthetics in the
Puritan Plain Style

9:50 AM—10:30 AM

William M. Marsh

(Cedarville University)

The Holy Spirit as the Eternal

"Listener" in Luther's Sermons on the
Gospel of John

10:40 AM—11:20 AM

Brian L. Hanson

(Bethlehem College & Seminary)

Reading the Spirit in the Psalms:

Protestant Pneumatology and the
Psalter in Reformation England

11:30 AM—12:10 PM

Garrick M. Bailey

(Southern Baptist Theological Seminary)

Herman Bavinck on the Immediate

Operation of the Holy Spirit and the
Means of Grace

T 9:00 AM-12:10 PM

Holy Spirit - New Testament

General Studies

Tower Building – Mezzanine Level

Century

Moderator: David Alan Reed

(United Methodist Church - Detroit
Conference)

9:00 AM—9:40 AM

Sungmin Joe Park

(University of Aberdeen)

Trinitarian Mystery in the Three

Baptisms in Luke – Acts

9:50 AM—10:30 AM

Doug Holm

(Denver Seminary)

1 Peter's Use of the Holy Spirit

10:40 AM—11:20 AM

S. M. Baugh

(Westminster Seminary California)

Whose Spirit? Christ's Spirit or the

Holy Spirit in Hebrews 9:14

11:30 AM—12:10 PM

Rodolfo Galvan Estrada III

(LABI College)

Contending for the Spirit in the Letter
of Jude

T 9:00 AM-12:10 PM

Holy Spirit - New Testament

Pauline Literature 1

Tower Building – 2nd Floor

Windows

Moderator: Alan J. Thompson

(Sydney Missionary and Bible College)

9:00 AM—9:40 AM

Kris Song

(University of Aberdeen)

What is the Unity of the Spirit?

Tuesday, November 13 9:00 AM – 12:10 PM

9:50 AM—10:30 AM

Vern S. Poythress

(Westminster Theological Seminary,
Philadelphia)

The Boundaries of the Gift of
Tongues: With Implications for
Cessationism and Continuationism

10:40 AM—11:20 AM

Larry D. Pettegrew

(Shepherds Theological Seminary)

Rethinking "Face to Face" (1
Corinthians 13)

11:30 AM—12:10 PM

Timothy J. Christian

(Asbury Theological Seminary)

The Holy Spirit and Rhetoric:
Mutually Exclusive or Rejecting
Sophism?

T 9:00 AM-12:10 PM

Holy Spirit - New Testament

Pauline Literature 2

Tower Building – Mezzanine Level
Spruce

Moderator: Scott A. Swanson

(Providence Christian College)

9:00 AM—9:40 AM

James P. Sweeney

(Winebrenner Theological Seminary)

The Spirit's Warning of Apostasy in 1
Tim. 4:1-3: A Pressing Concern in 1
Timothy

9:50 AM—10:30 AM

Luke Richard Hoselton

(Grand Canyon University)

Christ in You: An Investigation of the
Holy Spirit's Diminished Role in
Colossians

10:40 AM—11:20 AM

Joshua M. Greever

(Grand Canyon University)

What Does It Mean to Grieve the
Holy Spirit (Ephesians 4:30)?

11:30 AM—12:10 PM

Casey B. Hough

(New Orleans Baptist Theological
Seminary)

"Not By Might, But By Your Spirit" -
Zechariah's Influence on Paul's View
of the Holy Spirit

T 9:00 AM-12:10 PM

Holy Spirit - Old Testament

General Studies 1

Tower Building – Majestic Level
Vail

Moderator: Abraham Chacko

(Grace Bible Chapel)

9:00 AM—9:40 AM

Abner Chou

(The Master's University and Seminary)

The Spirit's Indwelling in the Old
Testament: Ezekiel's Contribution to
the Discussion

9:50 AM—10:30 AM

W. Creighton Marlowe

(Evangelische Theologische Fakultät)

Where is the Spirit in the Old
Testament?

10:40 AM—11:20 AM

Lance Higginbotham

(Trinity Evangelical Divinity School)

The Holy Spirit as the Giver of
Wisdom in Biblical Theology

11:30 AM—12:10 PM

Daniel S. Diffey

(Grand Canyon University)

Charismatic Leadership, the Spirit of
Yahweh, and the Judges of Israel

T 9:00 AM-12:10 PM

Holy Spirit - Practical Theology

General Studies 1

Plaza Building – Lobby Level

Director's Row E

9:00 AM—9:40 AM

Micah S. Meek

(South University-Montgomery)

The Role of the Spirit in Relation to
the Conscience

9:50 AM—10:30 AM

Mark D. Liederbach

(Southeastern Seminary)

The Role of the Holy Spirit in Ethical
Formation

10:40 AM—11:20 AM

Alistair I. Wilson

(Edinburgh Theological Seminary)

The Holy Spirit in Mission and World
Christianity: A Reformed Perspective

11:30 AM—12:10 PM

Paul A. Hoffman

(Evangelical Friends Church of Newport,
Rhode Island)

The Missiological Debate over Acts
2:14-21: Examining Differing
Hermeneutics and Implications

T 9:00 AM-12:10 PM

Holy Spirit - Systematic Theology

Biblical Theology

Tower Building – 2nd Floor

Grand Ballroom I

Moderator: Agam Iheanyi-Igwe

(Northwest Christian University)

Tuesday, November 13th 9:00 AM – 12:10 PM

9:00 AM—9:40 AM

Gregg Allison

(Southern Baptist and Southeastern Baptist Theological Seminary)

Andreas J. Köstenberger

(Midwestern Baptist Theological Seminary)

A Biblical and Systematic Theology of the Holy Spirit

9:50 AM—10:30 AM

A. Chadwick Thornhill

(Liberty University School of Divinity)
The Spirit Moves Where It Will: A Narrative Theology of the Spirit

10:40 AM—11:20 AM

Jeffrey Riley

(New Orleans Baptist Theological Seminary)

Return to Paradise: Storying the Holy Spirit in the Narrative Significance of the Tree of Life

11:30 AM—12:10 PM

Wayne Grudem

(Phoenix Seminary)

What Does It Mean to Be "Led by the Spirit" (Rom. 8:14; Gal. 5:18)?

T 9:00 AM-12:10 PM

Holy Spirit - Systematic Theology

Contemporary Evangelicalism and Mission

Plaza Building – Concourse Level
Governor's Square 11

Moderator: Andrew B. Spurgeon
(Singapore Bible College)

9:00 AM—9:40 AM

Hank Voss

(Taylor University)

The Holy Spirit, the *missio Dei*, and the Mission of Every Believer in a North American Context

9:50 AM—10:30 AM

Joshua Chatraw

(Liberty University)

Taylor Worley

(Trinity International University)
Theology for Culture: Recovering the Missional Ethics of the Spirit in Acts

10:40 AM—11:20 AM

Zhiqiu Xu

(Columbia International University)
Reactivating the Transformative Power of the Holy Spirit among the Evangelical Churches in China

11:30 AM—12:10 PM

C. Ryan Fields

(Trinity Evangelical Divinity School)
Free Church & *Filioque*? On the Prospect of Free Church Engagement with the Doctrinal Controversy

T 9:00 AM-12:10 PM

Holy Spirit - Systematic Theology

Hermeneutics

Plaza Building – Concourse Level
Governor's Square 10

Moderator: Kyle W. Bagwell
(Southern Baptist Theological Seminary)

9:00 AM—9:40 AM

Nathan G. Wheeler

(Liberty University)
The Spiritual Dynamics of Biblical Interpretation According to the Semeiotic of C. S. Peirce

9:50 AM—10:30 AM

Will Bankston

(Trinity Evangelical Divinity School)

Falsehood, Futility, and Illuminated Agency: An Augustinian Account of Scriptural Understanding

10:40 AM—11:20 AM

Derek W. Taylor

(Whitworth University)

Reading "Against Ourselves": Dietrich Bonhoeffer on the Holy Spirit and the Logic of Interpretation

11:30 AM—12:10 PM

Joseph A. Kim

(Lancaster Bible College)
Rethinking the Spirit's Role in Hermeneutics: Pneumatology and Theological Interpretation

D 9:00 AM-12:10 PM

Church History

Church Fathers

Tower Building – Terrace Level
Columbine

Moderator:

Matthew Steven Bracey
(Welch College)

9:00 AM—9:40 AM

Christopher A. Graham

(Criswell College)
(Mis)Naming God in Second-Century Christian Polemics

9:50 AM—10:30 AM

D. Jeffrey Bingham

(Southwestern Baptist Theological Seminary)
God, Humanity and Time in Irenaeus of Lyons

10:40 AM—11:20 AM

Gerald Hiestand

(Calvary Memorial Church/Center for Pastor Theologians)

Tuesday, November 13 9:00 AM – 12:10 PM

The Envious Steward: How Irenaeus' Account of the Devil De-Platonizes the Christian Narrative

11:30 AM—12:10 PM

Bradley G. Green

(Union University)

Augustine, Pelagius, and Original Sin: Reflections on an Old Problem

D 9:00 AM-12:10 PM

Church History

Medieval Era

Tower Building – Terrace Level
Beverly

Moderator: Andre Gazal

(North Greenville University)

9:00 AM—9:40 AM

Francis X Gumerlock

(University of Colorado at Colorado Springs)

An Eleventh-Century Text in Which the Rapture Occurs Six Years before the Last Judgment

9:50 AM—10:30 AM

Esther G. Cen

(McMaster Divinity College)

Hearing the Medieval Byzantine Greek Lectionary MSS

10:40 AM—11:20 AM

Madison Trammel

(Midwestern Baptist Theological Seminary)

John Wycliffe's Eucharistic Theology in Ontological Context

11:30 AM—12:10 PM

Mark Fugitt

(Midwestern Baptist Theological Seminary)

The Spanish Reconquista as a Theological Movement

D 9:00 AM-12:10 PM

Exploring 18th Century

Evangelicalism: A Survey of Piety and Theology

Tower Building – Mezzanine Level
Colorado

Moderators:

David Mark Rathel

(University of St Andrews)

Steve Weaver

(Southern Baptist Theological Seminary)

9:00 AM—9:40 AM

Joseph Harrod

(Southern Baptist Theological Seminary)

A 'Happy Union': Piety in the Marriage of Philip and Mercy
Doddridge

9:50 AM—10:30 AM

Chris Chun

(Gateway Seminary)

Jonathan Edwards as Proto-Baptist: Interdenominational Dialogue

10:40 AM—11:20 AM

David Norman

(Midwestern Baptist Theological Seminary)

Between Archibald McLean & Andrew Fuller: Abraham Booth on Faith, Repentance, & Justification

11:30 AM—12:10 PM

Peter Beck

(Charleston Southern University)

William Carey, the Modern Question and a Theology for Missions

D 9:00 AM-12:10 PM

New Testament

Acts

Tower Building – 2nd Floor
Tower Court A

Moderator: Simon Knighten

(McMaster Divinity College)

9:00 AM—9:40 AM

Craig Price

(New Orleans Baptist Theological Seminary)

The Holy Spirit Rightly Spoke through Isaiah: An Inner-Biblical Examination of Acts 28:25 – 28

9:50 AM—10:30 AM

Charles Savelle

(Southwestern Baptist Theological Seminary)

Infanticide in the Apostolic Decree of Acts 15?

10:40 AM—11:20 AM

Charles E. Cruise

(Trinity Evangelical Divinity School)

The Weakness of the Law in Acts 13:38 – 39

11:30 AM—12:10 PM

Isaac Blois

(Biola University)

The Church as Distribution Center: Distribution of Spirit in Acts 2:3 and Resources in Acts 2:45

D 9:00 AM-12:10 PM

Old Testament

General Studies

Tower Building – Terrace Level
Capitol

Moderator: Adam J. Howell

(Boyce College/Southern Seminary)

9:00 AM—9:40 AM

Cooper Smith

(Wheaton College)

What to do with Elihu: Elihu as a Case Study for Practicing Wisdom

Tuesday, November 13th 9:00 AM – 12:10 PM

9:50 AM—10:30 AM

Hee Suk Kim

(Chongshin University)

Proverbs 30-31 as a Hermeneutical
Conclusion to the Book of Proverbs

10:40 AM—11:20 AM

Mark Baker

(Southeastern Baptist Theological
Seminary)

Walking in the Blameless Way: A
Study of Blamelessness in the Old
Testament Wisdom Literature

11:30 AM—12:10 PM

Matthew R. Miller

(Southern Baptist Theological Seminary)

Origen's Aristarchian Signs in Light
of Recent Research

D 9:00 AM-12:10 PM

Old Testament

Isaiah and Jeremiah

Tower Building – Majestic Level
Savoy

Moderator: Glenn R. Matlock, Jr.

(Trinity Baptist Church/Ingle Chapel)

9:00 AM—9:40 AM

Benjamin M. Smith

(Wheaton College)

"Offspring like the Sands":

Abraham's Offspring in the Book of
Isaiah

9:50 AM—10:30 AM

Daniel C. Timmer

(Puritan Reformed Theological Seminary)

The Non-Israelite Nations in Isaiah:
Exploring Coherence and Unity amid
Diversity

10:40 AM—11:20 AM

Gary E. Yates

(Liberty University School of Divinity)

Infidelity, Divorce, and Return to the
Lord: The Influence of Deut 24 on Hos
5 and Jer 3

11:30 AM—12:10 PM

Mark A. Jumper

(Regent University School of Divinity)

Jus Post Bellum Broken:
Nebuchadnezzar, Gedaliah, and
Jeremiah

D 9:00 AM-12:10 PM

Old Testament

Pentateuch 1

Plaza Building – Concourse Level
Plaza Court 7

Moderator: Allan Moseley

(Southeastern Baptist Theological
Seminary)

9:00 AM—9:40 AM

Jo Ann Davidson

(Andrews University Theological
Seminary)

Joseph, Judah, and Jesus---Revisiting
Genesis 37-50

9:50 AM—10:30 AM

Michael A. Harbin

(Taylor University)

Evaluating Categories of Widows in
Old Testament Law

10:40 AM—11:20 AM

G. Geoffrey Harper

(Sydney Missionary & Bible College)

"Do Not Eat the Owl": Hearing
Leviticus 11 as Christian Scripture

11:30 AM—12:10 PM

Pete Goeman

(Shepherds Theological Seminary)

Prophetic Certainty and Israel's
Repentance in Deuteronomy 4:29

D 9:00 AM-12:10 PM

Old Testament

Psalms

Tower Building – Majestic Level
Majestic Ballroom

Moderator: Kevin Chen

(Union University)

9:00 AM—9:40 AM

C. Hassell Bullock

(Wheaton College, IL)

The Formula of Grace Redaction of
the Psalter

9:50 AM—10:30 AM

Dustin Jeremy Coleman

(Midwestern Baptist Theological
Seminary)

An Exegesis of Psalm 90 in Light of
the Old Testament Narrative

10:40 AM—11:20 AM

Gunner Gundersen

(BridgePoint Bible Church)

Satan and the Structure of the
Psalms: Psalm 91:11-12 in Matthew
4:5-6

D 9:00 AM-12:10 PM

Perspectives on the Spiritual Gifts

Plaza Building – Concourse Level
Governor's Square 14

Moderator: Patrick Schreiner

(Western Seminary)

9:00 AM—9:25 AM

Andrew Wilson

(Kings Church London)

The Continuation of the Charismata

9:25 AM—9:45 AM

Respondent: Thomas R. Schreiner

(Southern Baptist Theological Seminary)

Tuesday, November 13 9:00 AM – 12:10 PM

9:45 AM—10:05 AM

Respondent: J. Ligon Duncan
(Reformed Theological Seminary)

10:15 AM—10:40 AM

Thomas R. Schreiner
(Southern Baptist Theological Seminary)
It All Depends upon Prophecy

10:40 AM—11:00 AM

Respondent: Sam Storms
(Bridgeway Church/Enjoying God Ministries)

11:00 AM—11:20 AM

Respondent: Andrew Wilson
(Kings Church London)

11:30 AM—11:50 AM

Open Discussion

11:50 AM—12:10 PM

Questions from the Floor

D 9:00 AM-12:10 PM

Practical Theology

General Studies 1

Tower Building – 2nd Floor

Grand Ballroom II

Moderator: Jessica Wan
(Tyndale University College)

9:00 AM—9:40 AM

Timothy Paul Jones
(Southern Baptist Theological Seminary)

Gabriel Etzel
(Liberty University)

John Cartwright
(Liberty University School of Divinity)

Christopher D. Jackson
(Concordia University Wisconsin)
Developing a Model of Online
Theological Education that Forms
Ministers and Shapes Souls

9:50 AM—10:30 AM

David M. Toledo
(Southwestern Baptist Theological Seminary)
Embracing the Challenge: Questions
and Answers in Music and Worship
Leadership Education

10:40 AM—11:20 AM

Jason K. Allen
(Midwestern Baptist Theological Seminary)
Reformation Homiletics: Assessing
Calvin's Method of Preaching Christ
from the Old Testament

11:30 AM—12:10 PM

Garet D. Robinson
(University Baptist Church, Houston)
A Theological Evaluation of the
Revisions in the Christian Standard
Bible

D 9:00 AM-12:10 PM

Systematic Theology

Biblical Theology

Plaza Building – Lobby Level

Director's Row I

Moderator: Rita F. Cefalu
(San Diego, CA)

9:00 AM—9:40 AM

Brent E. Parker
(Southern Baptist Theological Seminary)
Biblical Typology: A Summary of
Recent Evangelical Proposals

9:50 AM—10:30 AM

Albert L. Shepherd V
(Samford University)
The Fear of the Lord is the Beginning
of Theology

10:40 AM—11:20 AM

David Larsen
(St. Mary's University, Twickenham, UK)
Two Narratives, Two Missions, One
Canon

11:30 AM—12:10 PM

John Wivell
(Clarks Summit University)
Typology in the Context of Prophecy:
Prefiguration or Analogy?

D 9:00 AM-12:10 PM

Systematic Theology

Christology

Plaza Building – Lobby Level

Director's Row J

Moderator: Steven Tsoukalas
(Emmaus Biblical Seminary, Haiti)

9:00 AM—9:40 AM

Rafael Bello
(Martin Bucer Seminary)The Humanity of
Christ in T. F. Torrance's Theology

9:50 AM—10:30 AM

Ronni Kurtz
(Midwestern Baptist Theological Seminary)
B.B. Warfield's Doctrine of
Hypostatic Union and its
Soteriological Significance

10:40 AM—11:20 AM

Michael A. Wilkinson
(Southern Baptist Theological Seminary)
The Impeccability of the Obedient
Son Incarnate: A Person-Centric
Approach

11:30 AM—12:10 PM

Jared H. Moore
(Southern Baptist Theological Seminary)
The Gordon Clark and Cornelius Van
Til Controversy

Tuesday AM – PM

D 9:00 AM-12:10 PM

Systematic Theology

Social Justice and Ecclesiology

Plaza Building – Lobby Level

Director's Row H

Moderator: Daniel Rodriguez
(Pepperdine University)

9:00 AM—9:40 AM

Kenneth J. Reid

(Grand Rapids Theological Seminary)
The Holy Spirit and Unity:
Implications for an Evangelical
Theology of Social Justice

9:50 AM—10:30 AM

Craig Sanders

(Saint Louis University)
The Spirit's Passion for Justice:
Advocating for the Weak and
Empowering the Church

10:40 AM—11:20 AM

Katie McCoy

(Southwestern Baptist Theological
Seminary)
What's Missing From #MeToo: How
the Christian Worldview Defends
Women's Dignity

11:30 AM—12:10 PM

Timothy D. Padgett

(The Colson Center for Christian
Worldview)
The Slaver's Bible: How Pro-Slavery
Theologians (Mis)Used Scripture to
Justify Slavery

D 9:00 AM-12:10 PM

Systematic Theology

Theology Proper and Impassibility

Plaza Building – Concourse Level

Governor's Square 15

Moderator: R. Bruce Compton
(Detroit Baptist Theological Seminary)

9:00 AM—9:40 AM

Jonathan King

(Universitas Pelita Harapan)
A Theological Aesthetic Model of the
Doctrine of God, and Notably with
Respect to God the Son

9:50 AM—10:30 AM

Mark A. Snoeberger

(Detroit Baptist Theological Seminary)
Did God Die on the Cross? A Proposal
for Harmonizing Divine Impassibility
with Christ's Passion

10:40 AM—11:20 AM

Joshua Kira

(Cedarville University)
John R Gilhooly
(Cedarville University)
Emotions, Feelings, and the Question
of Impassibility

11:30 AM—12:10 PM

Wayne E. Cornett

(Mid-America Baptist Theological
Seminary Northeast)
Impassability, Patripassianism, and
Eternal Functional Subordination in
Trinitarian Debate

12:15 PM – 1:45 PM

Lunch Break

P 2:00 PM-5:10 PM

Biblical Theology

The State of Biblical Theology in the Twenty-First Century

Tower Building – 2nd Floor

Grand Ballroom I

Moderator: Robert W. Yarbrough
(Covenant Theological Seminary)

2:00 PM—2:40 PM

Eckhard Schnabel

(Gordon-Conwell Theological Seminary)
Biblical Theology from a New
Testament Perspective

2:50 PM—3:30 PM

Michael Bird*

(Ridley College)
Biblical Theology between History
and Theological Interpretation

3:40 PM—4:20 PM

Craig Carter

(Tyndale University College and
Seminary)
The Role of Nicene Metaphysics in
Biblical Theology: A Proposal

4:30 PM—5:10 PM

Panel Discussion

P 2:00 PM-5:10 PM

Christian Ethics

Plaza Building – Concourse Level

Plaza Court 7

Moderator: Bryan Baise

(Boyce College)

2:00 PM—2:40 PM

Jacob Shatzer

(Union University)
Robots, Jobs, and Leisure: Being
Human in the Face of Technological
Disruption

2:50 PM—3:30 PM

Branson Parler

(Kuyper College)

*Invited Guest of ETS

Tuesday, November 13 2:00 PM – 5:10 PM

Ancient-Future Sex: Retrieving the Good of Procreation for Contemporary Sexual Ethics

3:40 PM—4:20 PM

Justin Zahraee

(Wheaton College)

The Epistle of James as a Way Forward in the Creation Versus Kingdom Ethical Debate

4:30 PM—5:10 PM

Ken Magnuson

(Southern Baptist Theological Seminary)

The Surrogacy Solution to Infertility: A Moral Evaluation

P 2:00 PM-5:10 PM

Christianity and Culture **Cultural Conflicts**

Plaza Building – Lobby Level

Director's Row J

Moderator: John Adair

(Dallas Theological Seminary)

2:00 PM—2:40 PM

John D. Laing

(Southwestern Baptist Theological Seminary)

Answering Islamic State: A Modest Proposal

2:50 PM—3:30 PM

Kyle Meeker

(Northview Community Church)

To Benedict, or Not to Benedict? ... Amidst the Pedagogical Enthronement of Transgenderism

3:40 PM—4:20 PM

John W. Auxier

(Trinity Western University)

Identity, Culture and Christian Faith in the Comics of Gene Luen Yang

4:30 PM—5:10 PM

Mark Stephens

(Excelsia College)

Faithful Witness: Victory without *Ressentiment* in the Apocalypse of John

P 2:00 PM-5:10 PM

Creation

Tower Building – Terrace Level

Terrace

Moderator: Kyle C. Dunham

(Detroit Baptist Theological Seminary)

2:00 PM—2:25 PM

Jeremy Lyon

(Truett McConnell University)

Gen 1:1 – 3 and the Literary Boundary of Day One—A Young-Earth Perspective

2:30 PM—2:55 PM

John Hilber

(Grand Rapids Theological Seminary)

Gen 1:1-3—Sorting the Options from an Old-Earth Perspective

3:00 PM—3:30 PM

Panel Discussion and Q&A

3:40 PM—4:05 PM

Guang Chen

(Trinity Evangelical Divinity School)

Genesis 2:4-7—An Old-Earth Creationist Interpretation

4:10 PM—4:35 PM

Todd Beall

(Liberty University)

Genesis 2:4-7—A Young-Earth Creationist Interpretation

4:40 PM—5:10 PM

Panel Discussion and Q&A

P 2:00 PM-5:10 PM

Evangelicals and Gender

Sexual Abuse, Gender and Power

Plaza Building – Concourse Level

Governor's Square 14

Moderators:

Cynthia Long Westfall

(McMaster Divinity College)

Gerry Breshears

(Western Seminary)

2:00 PM—2:40 PM

Rachael Denhollander*

(J.D. and Victim Advocate)

Jacob Denhollander

(Southern Baptist Theological Seminary)

Justice: The Foundation of a Christian Approach to Abuse

2:50 PM—3:30 PM

Igrid Faro

(Northern Seminary)

Abuse: What Is It? Why Is It? And What Can We Do about It

3:40 PM—4:20 PM

Steven Tracy

(Phoenix Seminary)

#Metoo and Evangelicalism:

Shattering Myths about Sexual Abuse and Power

4:30 PM—5:10 PM

Mimi Haddad

(Fuller/CBE International)

A Thorn by Any Other Name: Dominance and Its Role in Abuse

*Invited Guest of ETS

Tuesday, November 13 2:00 PM – 5:10 PM

P 2:00 PM-5:10 PM

Hermeneutics

Plaza Building – Concourse Level
Governor's Square 16

Moderator: W. Edward Glenny
(University of Northwestern - St. Paul)

2:00 PM—2:40 PM

Chad Hardy

(Trinity Evangelical Divinity School)
Clarifying the Concept of
Accommodation

2:50 PM—3:30 PM

Andrew Ballitch

(Southern Baptist Theological Seminary)
Illumination: Locating the Spirit's
Work with John Owen

3:40 PM—4:20 PM

Kyle W. Bagwell

(Southern Baptist Theological Seminary)
The Holy Spirit's Evidential Witness

4:30 PM—5:10 PM

Timothy E. Miller

(Detroit Baptist Theological Seminary)
Defining the Categories of
Intertextual Reference: Quotation,
Allusion, Echo, and Trace

P 2:00 PM-5:10 PM

Luke / Acts

Tower Building – 2nd Floor
Tower Court A

Moderator: David Shackelford
(Mid-America Baptist Theological
Seminary)

2:00 PM—2:40 PM

Sergio A. Estrada

(College of Biblical Studies Houston)
Exegesis of the Gospel of Luke as
Reflected in the Writings of Three
Liberation Theologians

2:50 PM—3:30 PM

B.J. Hilbelink

(Trinity Evangelical Divinity School)
Philip and Elijah's Mantle:
Intertextuality and Missiology in Acts
8:26-40

3:40 PM—4:20 PM

Susan Hecht

(Denver Seminary)
Paul's Speech in Acts 14:14-18: A
Jewish Message to a Gentile
Audience?

4:30 PM—5:10 PM

Timothy A. Gabrielson

(Sterling College)
Paul as the New Stephen: Evaluating
"Paul within Judaism" in Acts

P 2:00 PM-5:10 PM

Method in Systematic Theology

Theological Method

Plaza Building – Lobby Level
Director's Row E

Moderator: Ken Keathley

(Southeastern Baptist Theological
Seminary)

2:00 PM—2:40 PM

Andrew Hollingsworth

(New Orleans Baptist Theological
Seminary)
Towards a Theological Pragmatism:
Charles Sanders Peirce for Theological
Method

2:50 PM—3:30 PM

Craig A. Hefner

(Wheaton College)
Immutability without Metaphysics: A
Kierkegaardian Account

3:40 PM—4:20 PM

Hongyi (June) Yang

(Southwestern Baptist Theological
Seminary)
How Can One Do Theology without
Terminologies?

4:30 PM—5:10 PM

Steve Sherman

(Grand Canyon University, College of
Theology)
Precommitments, Preunderstandings,
Presuppositions: Peculiar Power for
Theological Hermeneutics

P 2:00 PM-5:10 PM

New Testament Greek Language and Exegesis

The Letter to the Romans: Exegesis and Implications

Tower Building – Majestic Level
Vail

Moderator: Stanley E. Porter

(McMaster Divinity College)

2:00 PM—2:40 PM

Martin M. Culy

(Cypress Hills Ministries)
Romans 1:16-17: Are We Missing the
Point of Romans?

2:50 PM—3:30 PM

Daniel B. Wallace

(Dallas Theological Seminary)
Romans 4:1: Syntax and the New
Perspective

3:40 PM—4:20 PM

Stanley E. Porter

(McMaster Divinity College)
Romans 5:1: What a Difference an O
Can Make

Tuesday, November 13 2:00 PM – 5:10 PM

4:30 PM—5:10 PM

Frank Thielman

(Beeson Divinity School)

Romans 15:7-13: The Goal of the Gospel

P 2:00 PM-5:10 PM

Old Testament Narrative Literature

Tower Building – Terrace Level
Columbine

Moderator: Michael A. Grisanti
(The Master's Seminary)

2:00 PM—2:40 PM

Joey S. Woo

(Dallas Theological Seminary)

The Epithet "Michal, the Daughter of Saul" in Characterization: A Stand-in for Saul/His House?

2:50 PM—3:30 PM

Todd L. Patterson

(Matej Bel University)

Evidence that Jacob Never Relinquishes Reliance on his own Contrivances in the Isaac Tôlêdôt

3:40 PM—4:20 PM

Michelle Knight

(Trinity Evangelical Divinity School)

Spirals and Chiasms and Rings—Oh My!

4:30 PM—5:10 PM

Nathan Lovell

(George Whitefield College, South Africa)

Where is Yahweh found? Land and Worship in 1&2 Kings

P 2:00 PM-5:10 PM

Old Testament Theology

Legacy of Willem VanGemerem for Old Testament Theology

Tower Building – Majestic Level
Majestic Ballroom

2:00 PM—2:05 PM

Heath A. Thomas

(Oklahoma Baptist University)

Introduction to Session

2:05 PM—2:15 PM

Andrew Abernethy

(Wheaton College)

The Legacy of Willem VanGemerem

2:15 PM—2:40 PM

John Monson

(Trinity Evangelical Divinity School)

Geo-Canonical Interpretation: Context and Canon

2:40 PM—2:50 PM

Respondent:

Willem VanGemerem*

(Trinity Evangelical Divinity School)

2:55 PM—3:20 PM

Stephen Dempster

(Crandall University)

The Tri-Partite Canon and the Theology of the Prophetic Word

3:20 PM—3:30 PM

Respondent:

Willem VanGemerem*

(Trinity Evangelical Divinity School)

3:35 PM—4:00 PM

M. Daniel Carroll R.

(Wheaton College)

Ethics in Old Testament Theologies

4:00 PM—4:10 PM

Respondent:

Willem VanGemerem*

(Trinity Evangelical Divinity School)

4:15 PM—4:40 PM

Dana M. Harris

(Trinity Evangelical Divinity School)

Typological Trajectories: Reading the Old with the New

4:40 PM—4:50 PM

Respondent:

Willem VanGemerem*

(Trinity Evangelical Divinity School)

4:55 PM—5:10 PM

Conclusion

P 2:00 PM-5:10 PM

Patristic and Medieval History

Blessedness and Grace, Buildings and Manuscripts

Plaza Building – Concourse Level
Plaza Court 6

Moderator: W. Brian Shelton
(Toccoa Falls College)

2:00 PM—2:40 PM

Brian J. Arnold

(Phoenix Seminary)

"To Behold Its Own Delight": The Beatific Vision in Irenaeus of Lyons

2:50 PM—3:30 PM

Kurt Jaros

(University of Aberdeen)

Was Vincent of Lérins an Augustinian on the Doctrine of Grace? A Reply to Recent Arguments

3:40 PM—4:20 PM

Scott Harrower

(Ridley College)

Visual Exegesis at 'The World's Oldest Church': The Way Forward

*Invited Guest of ETS

Tuesday, November 13 2:00 PM – 5:10 PM

4:30 PM—5:10 PM

William C. Watson

(Colorado Christian University)

Cumynge of Antecryst: An Early
Fifteenth Century Middle-English
Gothic Manuscript

P 2:00 PM-5:10 PM

Psalms and Hebrew Poetry

Tower Building – Terrace Level
Beverly

Moderator: Michael McKelvey
(Reformed Theological Seminary)

2:00 PM—2:40 PM

Lance M. Kramer

(Bethlehem College & Seminary)

The Sacrifice of Praise in Psalm 49
LXX

2:50 PM—3:30 PM

Stephen J. Smith

(Southern Baptist Theological Seminary)

The Function of a Motif in the
Psalter: Enemy Quotations That
Attack God

3:40 PM—4:20 PM

Ian J. Vaillancourt

(Heritage Seminary)

Hope in a Coming Son of David and
Prophet Like Moses: Psalm 118 in
Canonical Perspective

4:30 PM—5:10 PM

Andrew C. Witt

(Wycliffe College)

From the "End" to the "Overseer":
Journeying with *למנצח* through the
History of Interpretation

P 2:00 PM-5:10 PM

Synoptic Gospels

Tower Building – Majestic Level
Savoy

Moderator: Michael H. Burer

(Dallas Theological Seminary)

2:00 PM—2:40 PM

Gregory S. Thellman

(Evangelical Theological Seminary (Osijek,
Croatia))

The Narrative-Theological Function
of Matthew's Baptism Command
(Matt 28:19)

2:50 PM—3:30 PM

Caleb T. Friedeman

(Ohio Christian University)

Luke and the Messianic Secret: The
Modulation of a Marcan Theme

3:40 PM—4:20 PM

Nathan LeMahieu

(Wheaton College)

Luke's Feeding of the Multitude (Luke
9:10 – 17) and Isaiah's Eschatological
Banquet

4:30 PM—5:10 PM

Bruce Henning

(Trinity College - Bristol)

The Apostles as the Messiah's Kingly
and Prophetic Shepherds of Jer 23

P 2:00 PM-5:10 PM

Theology for Counseling and Pastoral Care

Union with Christ, Sanctification,
& Psychotherapy: Reflections on
Eric L. Johnson's *God and Soul
Care* (IVP, 2017)

Tower Building – Mezzanine Level
Silver

Moderator: Keith Plummer
(Cairn University)

2:00 PM—2:40 PM

Stephen P. Greggo

(Trinity Evangelical Divinity School)

The Holy Spirit in Counseling:
Recognition, Receptiveness, and,
Realization

2:50 PM—3:30 PM

E. Janet Warren

(Bayridge Counselling Centre)

Spirit Speaks to Spirit: Divine
Communication in Christian
Counseling

3:40 PM—4:20 PM

H. Stephen Berger

(TEM Consulting)

Community Impact on Soul Care

4:30 PM—5:10 PM

Daniel K. Eng

(University of Cambridge)

How the New Testament Addresses
the Counseling Stigma for Asian
Americans

A 2:00 PM-5:10 PM

Evangelical Philosophical Society B1

Tower Building – 2nd Floor
Tower Court B

Moderator: David E. Alexander
(Huntington University)

2:00 PM—2:40 PM

Brandon Rickabaugh

(Baylor University)

Seeing Darkly: Divine Hiddenness,
Cognitive Science, and the Hidden
Self

Tuesday, November 13 2:00 PM – 5:10 PM

2:50 PM—3:30 PM

Daniel von Wachter

(IAP Liechtenstein)

Divine Interventions are not
Violations of the Laws of Nature

3:40 PM—4:20 PM

Jon Kelly

(Biola University)

Restructuring the Structure of Your
Soul

4:30 PM—5:10 PM

Connor Dealy

(Talbot School of Theology)

The Limits of Aristotelian Causation:
Towards a "New" Analysis of
Omnipotence

A 2:00 PM-5:10 PM

Evangelical Philosophical Society B2

Tower Building – 2nd Floor

Tower Court C

Moderator: W. Paul Franks

(Tyndale University College)

2:00 PM—2:40 PM

Elijah Hess

(University of Arkansas)

On the Possibility of Divine
Foreknowledge: A Reply to Tooley

2:50 PM—3:30 PM

J.T. Turner

(Anderson University)

The Mind of the Spirit in the
Resurrected Human: A Model of
Mereological Saturation

3:40 PM—4:20 PM

Jacob Brunton

(Southwestern Baptist Theological
Seminary)

Divine Egoism: An Edwardsian
Theodicy

4:30 PM—5:10 PM

Kegan J. Shaw

(University of Edinburgh)

Having Practical Knowledge of the
Gospel of God: A Theory of Special
Knowledge

A 2:00 PM-5:10 PM

Evangelical Philosophical Society B3

Tower Building – 2nd Floor

Tower Court D

Moderator: Chris D. Lee

(Southwestern Baptist Theological
Seminary)

2:00 PM—2:40 PM

Paul Copan

(Palm Beach Atlantic University)

Deconversion: Why People Leave the
Christian Faith--and (Re)turn to It

2:50 PM—3:30 PM

Dwight R. Stanislav

(Holy Apostles College & Seminary)

A Lack of Substance: Thomas
Aquinas, Substances, and Modern
Dualism

3:40 PM—4:20 PM

Justin J. Daeley

(University of Northwestern – St. Paul)

The Necessity of the Best Possible
World, Divine Thankworthiness, and
Grace

4:30 PM—5:10 PM

Eric Yang

(Santa Clara University)

Kenoticism and Perfect-Being
Theology

A 2:00 PM-5:10 PM

Near East Archaeological Society B

Challenging Generally Accepted
Archaeological Paradigms

Plaza Building – Concourse Level

Governor's Square 17

Moderator: Donald McNeeley

(Tidewater Bible College)

2:00 PM—2:40 PM

Henry B. Smith

(Associates for Biblical Research)

On the Authenticity of Kainan, Son
of Arpachshad

2:50 PM—3:30 PM

Craig Olson

(Trinity Southwest University)

Steve Collins

(Veritas International University)

Challenging Generally Accepted
Biblical Paradigms in Archaeology

3:40 PM—4:20 PM

Seth Rodriguez

(Colorado Christian University)

Great Cities You Did Not Build: An
Alternative Explanation of Israel's
Emergence in Iron Age I

4:30 PM—5:10 PM

Adeeb Mickahail

(Liberty University)

"YHWH and His Asherah" from
Kuntillet 'Ajrud and Khirbet El-Qum

Tuesday, November 13 2:00 PM – 5:10 PM

T 2:00 PM-5:10 PM

Holy Spirit - Church History

17th-18th Century England

Plaza Building – Concourse Level
Governor's Square 11

Moderator: Barry Joslin
(Boyce College)

2:00 PM—2:40 PM

Jonathan Arnold

(Boyce College)

'The Voluntary Author of All Divine Operations': The Holy Spirit in Late-17th-Century England

2:50 PM—3:30 PM

Andre Gazal

(North Greenville University)

"The Spirit that Loveth Unanimity": Lancelot Andrewes' Doctrine of the Holy Spirit

3:40 PM—4:20 PM

Ty Kieser

(Wheaton College)

The Holy Spirit and the Humanity of Christ in John Owen: A Re-Examination

4:30 PM—5:10 PM

John Gray

(Southwestern Baptist Theological Seminary)

The Influence of the General Baptist Tradition on Benjamin Keach's Pneumatology

T 2:00 PM-5:10 PM

Holy Spirit - Church History

Patristic and Medieval Era

Plaza Building – Lobby Level
Director's Row I

Moderator: Rex Butler
(New Orleans Baptist Theological Seminary)

2:00 PM—2:40 PM

Thomas P. Johnston

(Midwestern Baptist Theological Seminary)

The Holy Spirit's Work According to Peter the Lombard's "Four Books of Sentences"

2:50 PM—3:30 PM

Carl B. Smith II

(South University, College of Theology)

The Holy Spirit in the Life and Letters of Ignatius of Antioch

3:40 PM—4:20 PM

Benjamin Browning

(New Orleans Baptist Theological Seminary)

Fighting over the Spirit: The Role of Violence in the Pneumatomachian Controversy

4:30 PM—5:10 PM

Michael J. Svigel

(Dallas Theological Seminary)

The Holy Spirit in the Apostolic Fathers: Lingering Challenges to the Orthodox, Protestant Faith

T 2:00 PM-5:10 PM

Holy Spirit - New Testament

Pauline Literature 3

Tower Building – 2nd Floor
Windows

Moderator: Douglas Estes
(South University, Columbia)

2:00 PM—2:40 PM

David P Barry

(Westminster Theological Seminary)

The Coming of the Spirit in Romans 8 as Restoration from Exile

2:50 PM—3:30 PM

Joshua Maurer

(Wheaton College)

'But You Received the Spirit of Adoption' (Rom 8:15): Love and the Logic of Filial Obedience

3:40 PM—4:20 PM

John Anthony Dunne

(Bethel Seminary (St. Paul))

'They Do Not Keep The Law' (Galatians 6.13): Forceful Circumcision and the Fruit of the Spirit

4:30 PM—5:10 PM

Thorvald Madsen

(Midwestern Baptist Theological Seminary and College)

The Gift and Task of Spiritual Life in Paul: A View from the Old Testament

T 2:00 PM-5:10 PM

Holy Spirit - Practical

Theology

Homiletics

Tower Building – Mezzanine Level
Spruce

Moderator: Cristina Richie
(East Carolina University)

2:00 PM—2:40 PM

Kevin King

(Liberty University)

Zwingli, Preaching and the Role of the Holy Spirit

2:50 PM—3:30 PM

Benjamin Phillips

(Southwestern Baptist Theological Seminary)

Tuesday, November 13 2:00 PM – 5:10 PM

The Spirit of Prophecy in the Pulpit:
Reconsidering Preaching as a Form of
Prophecy

3:40 PM—4:20 PM

Michael P. Knowles

(McMaster Divinity College)

Homiletics, Speech Act Theory, and
the Spirit of God

4:30 PM—5:10 PM

David W. Hall

(Midway Presbyterian Church)

John Calvin, the Holy Spirit, and
Preaching's 'Native Luster'

T 2:00 PM-5:10 PM

Holy Spirit - Systematic

Theology

General Studies 1

**Tower Building – Mezzanine Level
Gold**

Moderator: Kumiko Takeuchi

(Global Scholars)

2:00 PM—2:40 PM

Dongsun Cho

(Southwestern Baptist Theological
Seminary)

The Theological Reflections on the
Holy Spirit in the Passion and Death
of Christ

2:50 PM—3:30 PM

Kenny Silva

(Trinity Evangelical Divinity School)

The Spirit, the Church, and Triune
Light: Locating Tradition in the
Pattern of Divine Revelation

3:40 PM—4:20 PM

Andrew I. Shepardson

(Life Pacific College and the King's
University)

The Spirit of Truth and the Unmoved
Mover: The Presence of the Holy
Spirit and Natural Theology

4:30 PM—5:10 PM

Joanna M B Leidenhag

(University of Edinburgh)

The Giver of Life and the Question of
Vitalism

T 2:00 PM-5:10 PM

Holy Spirit - Systematic

Theology

General Studies 2

Plaza Building – Concourse Level

Plaza Court 8

Moderator: David H. Warren

(Brevard, NC)

2:00 PM—2:40 PM

Kimberley Kroll

(University of Saint Andrews)

The Analogy of the Vine: Grafting,
Transformation, and the Indwelling
Relation of the Holy Spirit

2:50 PM—3:30 PM

Adam Harwood

(New Orleans Baptist Theological
Seminary)

Contextualism: A Proposed Category
for Assessing Contemporary,
Miraculous Gifts

3:40 PM—4:20 PM

Rustin J. Umstattd

(Midwestern Baptist Theological
Seminary)

By the Breath of His Mouth: The
Spirit's Work in Judgment in 2
Thessalonians 2:8

4:30 PM—5:10 PM

Michael Steinmetz

(New Orleans Baptist Theological
Seminary)

The Practical Pneumatology of Søren
Kierkegaard

T 2:00 PM-5:10 PM

Holy Spirit - Systematic

Theology

The Trinity

**Tower Building – Mezzanine Level
Century**

Moderator: Kirk R. MacGregor

(McPherson College)

2:00 PM—2:40 PM

Matthew L. Tinkham Jr.

(Andrews University)

Hierarchy or Mutuality in the
Trinity? A Case Study on the
Relationship of the Spirit and Son

2:50 PM—3:30 PM

Gary W. Derickson

(Corban University)

Changing Roles of the Holy Spirit:
Evidence of Equality and Humility
within the Godhead

3:40 PM—4:20 PM

Robert M. Bowman Jr.

(Institute for Religious Research)

One Spirit, Five Views: Trinitarian
and Non-Trinitarian Theologies of
the Holy Spirit

4:30 PM—5:10 PM

Marty Folsom

(Shiloh University)

Does the Spirit Have a Voice?

Tuesday, November 13 2:00 PM – 5:10 PM

D 2:00 PM-5:10 PM

Church History

General Studies

Plaza Building – Concourse Level
Governor's Square 15

Moderator: Gregory A. Wills
(Southern Baptist Theological Seminary)

2:00 PM—2:40 PM

John D. Wilsey

(Southern Baptist Theological Seminary)
A Lock of Hair, a Ruined Cabin, and
a Party with Hitler: Historical
Empathy in Writing Biography

2:50 PM—3:30 PM

Irving Hexham

(University of Calgary)
The Holy Spirit and the Forgotten
Importance of Embedded Christianity

3:40 PM—4:20 PM

Jason G. Duesing

(Midwestern Baptist Theological
Seminary)
Historical Theology for the Church?
Retrospect & Prospect

4:30 PM—5:10 PM

James Leavenworth

(University of Edinburgh)
Ignatius of Antioch & the Smoking
Gun of Justification: The Meaning of
Dikaiō in the Ignatius

D 2:00 PM-5:10 PM

Church History

Luther and Calvin

Plaza Building – Concourse Level
Governor's Square 10

Moderator: Stewart Kelly
(Minot State University)

2:00 PM—2:40 PM

Trey Moss

(Southern Baptist Theological Seminary)
The Apocalyptic Conflict of the Cross
in Luther's 1531/1535 Commentary on
Galatians

2:50 PM—3:30 PM

Austin M. Freeman

(Trinity Evangelical Divinity School)
Calvin on Knowing God's Essence

3:40 PM—4:20 PM

Alden C. McCray

(University of St Andrews)
‘To Behold the Beauty of Jehovah’:
Calvin on the Sanctifying Nature of
God in the Psalms

4:30 PM—5:10 PM

James D. Gifford, Jr.

(Charlotte, NC)
The Origen of Calvinism: Theistic
Determinism as a Function of
Absolute Divine Simplicity

D 2:00 PM-5:10 PM

New Testament

Johannine Literature

Tower Building – Mezzanine Level
Colorado

Moderator: Leo Percer

(Liberty University)

2:00 PM—2:40 PM

Brian Tabb

(Bethlehem College & Seminary)
Petitionary Prayer in Apocalyptic
Perspective

2:50 PM—3:30 PM

Chris McElmurray

(New Orleans Baptist Theological
Seminary)

The Conquest of Joshua in the
Narrative Substructure of Revelation

3:40 PM—4:20 PM

Jeffrey R. Dickson

(Liberty University)
The Leonine Lamb of Revelation
5:6-10: Taking Another Look at
Christ's Apocalyptic Introduction

4:30 PM—5:10 PM

Stephen Rockwell

(George Whitefield College)
Nathanael as a Remnant Figure in
John's Gospel

D 2:00 PM-5:10 PM

New Testament

Matthew

Tower Building – Mezzanine Level
Denver

Moderator: Elijah Hixson

(Tyndale House, Cambridge)

2:00 PM—2:40 PM

B. Ward Powers

(Retired)
The Consequence of Monte Shanks
Research about Papias - & the
Evidence Paul Knew Matthew by
AD50

2:50 PM—3:30 PM

Chris Bruno

(Bethlehem College & Seminary)
Wonder Women: Gentile Women as
Savior Figures in Matthew's
Genealogy

3:40 PM—4:20 PM

Jeffrey A. Stivason

(Reformed Presbyterian Theological
Seminary)
The Sermon on the Mount Through
Matthew's Familial Lens

Tuesday, November 13 2:00 PM – 5:10 PM

4:30 PM—5:10 PM

Charles L. Quarles

(Southeastern Baptist Theological Seminary)

Matthew 16:2b – 3: New

Considerations for a Difficult Textual Question

D 2:00 PM-5:10 PM

New Testament

Synoptics

Tower Building – Terrace Level
Biltmore

Moderator: Brian Renshaw

(Southern Baptist Theological Seminary)

2:00 PM—2:40 PM

Robert Booth

(Southeastern Baptist Theological Seminary)

God as the Agent of Kingdom

Growth: An Argument for Divine Passives in Matt 13:32, 33

2:50 PM—3:30 PM

Jacob M. Pratt

(Southeastern Baptist Theological Seminary)

Covenant Lawsuit Through the Eyes of Matthew: *Μαρτύριον* and the *Rib*-Pattern in the First Gospel

3:40 PM—4:20 PM

Jason P Kees

(Midwestern Baptist Theological Seminary)

Where the Wild Animals Are: The Inauguration of the Last Days in Mark 1:12-13

4:30 PM—5:10 PM

Eric Turner

(Hannibal-LaGrange University)

A Crown of Suffering and Glory

D 2:00 PM-5:10 PM

Old Testament

Minor Prophets and Daniel

Tower Building – Terrace Level
Capitol

Moderator: Mark A. Hassler

(Virginia Beach Theological Seminary)

2:00 PM—2:40 PM

Richard Alan Fuhr Jr.

(Liberty University)

The Plausibility of an Assyrian Crisis Context for the Prophet Joel

2:50 PM—3:30 PM

Jennifer Brown Jones

(McMaster Divinity College)

Coded Critique, Validating Vestments: Joshua's Garments in Zechariah 3

3:40 PM—4:20 PM

E. Ray Clendenen

(Lifeway Christian Resources)

"Messenger of the covenant" in Malachi 3:1: John or Jesus?

4:30 PM—5:10 PM

Thomas Finley

(Talbot School of Theology)

Daniel's Vision of the Winged Lion in its Babylonian Context

D 2:00 PM-5:10 PM

Practical Theology

Beauty

Plaza Building – Lobby Level
Director's Row H

Moderator: Ryan A. Brandt

(Grand Canyon University)

2:00 PM—2:40 PM

Ryan A. Brandt

(Grand Canyon University)

The Beatific Vision as Spiritual Formation

2:50 PM—3:30 PM

Amanda K. Jenkins

(Grand Canyon University)

Sanctification as Beautification

3:40 PM—4:20 PM

Steven D. Boyer

(Eastern University)

Counterfeit Beauties: The Place of World Religions in a Theology Curriculum -- A Proposal

4:30 PM—5:10 PM

David Merrill

(Talbot School of Theology)

Beauty, Beatitude and Desire: a Reflection on the Theological Aesthetics of Thomas Traherne

D 2:00 PM-5:10 PM

Retrieving Eternal Procession

Plaza Building – Concourse Level
Governor's Square 12

Moderator: Oren Martin

(Southern Baptist Theological Seminary)

2:00 PM—2:40 PM

Gregg Allison

(Southern Baptist and Southeastern Baptist Theological Seminary)

Eternal Procession, Inseparable Operations, and the Mission of the Spirit

2:50 PM—3:30 PM

Steve Duby

(Grand Canyon University)

Divine Simplicity and the Eternal Procession of the Spirit

Tuesday PM // Wednesday AM

3:40 PM—4:20 PM

Fred Sanders

(Biola University)

Eternal Procession and the
Complicated Name of the Spirit

4:30 PM—5:10 PM

Tyler Wittman

(Southern Baptist Theological Seminary)

Eternal Procession and the Doctrine
of Creation

D 2:00 PM-5:10 PM

**The Nashville Statement:
Promise or Problem for
Evangelical Sexual Ethics?**

Tower Building – 2nd Floor

Grand Ballroom II

Moderator: Todd Wilson

(Center for Pastor Theologians)

2:00 PM—2:30 PM

Denny Burk

(Southern Baptist Theological Seminary)

Why Evangelicalism Needs the
Nashville Statement

2:35 PM—3:05 PM

Preston Sprinkle

(The Center for Faith, Sexuality &
Gender)

An Appreciative Disagreement with
the Nashville Statement

3:15 PM—3:45 PM

Andrew Walker

(The Ethics and Religious Liberty
Commission)

The Nashville Statement's Faithful
Witness and Transgender Identity

3:50 PM—4:20 PM

Joel Willitts

(Northpark University)

Why the Nashville Statement Does

More Harm Than Good

4:30 PM—5:10 PM

Panel Discussion

5:25 PM - 6:15 PM

ETS Plenary Session I

Plaza Building – Concourse Level

Plaza Ballroom

Michael A. G. Haykin

(Southern Baptist Theological Seminary)

"Not by might, nor by power, but by
my Spirit": The Holy Spirit & Human
Experience in the Long 18th Century

Wednesday

8:15 AM - 8:45 AM

Morning Prayer

Join us for a simple worship service of
scripture and prayer

P 8:30 AM-11:40 AM

American Christianity

**Snapshots from the Reformed
Tradition**

Tower Building – 2nd Floor

Tower Court A

Moderator: Don Westblade

(Hillsdale College)

8:30 AM — 8:55 AM

John S. Simons

(Trinity Evangelical Divinity School)

Witchcraft Accusations in Early New
England: A Comparative Approach

8:55 AM — 9:00 AM

Respondent: Robert Caldwell

(Southwestern Baptist Theological
Seminary)

Questions and Answers

9:20 AM — 9:45 AM

Michael J Plato

(Colorado Christian University)

Archibald Alexander and the
Reception of Scottish Philosophy at
Princeton

9:45 AM — 9:50 AM

Respondent: Paul Kjoss Helseth

(University of Northwestern - St. Paul)

Question and Answer

10:10 AM — 10:35 AM

Paul Kjoss Helseth

(University of Northwestern - St. Paul)

The Study of Old Princeton After the
Demise of the "Witherspoon
Problem"

10:35 AM — 10:40AM

Respondent: Michael J Plato

(Colorado Christian University)

Question and Answer

11:00 AM — 11:25 AM

Stephen J. Nichols

(Reformation Bible College)

The Life and Legacy of R.C. Sproul

11:25 AM — 11:30 AM

Respondent: Glenn R. Kreider

(Dallas Theological Seminary)

Question and Answer

Wednesday, November 14 8:30 AM – 11:40 AM

P 8:30 AM-11:40 AM

Asian/Asian-American Theology

Asian Pneumatology in the
Context of Asian-American
Church

Tower Building – Terrace Level
Terrace

Moderator: Ben Shin
(Talbot School of Theology)

8:30 AM—9:10 AM

Grace Sangalang Ng

(Talbot School of Theology)

The Holy Spirit's Transformation of
Shame into Honor in Romans 8

9:20 AM—10:00 AM

Sheryl Takagi Silzer

(Talbot School of Theology and Wycliffe)

How Culture shapes Theology/
Pneumatology: East vs West

10:10 AM—10:50 AM

Christopher D. Sneller

(Houston Baptist University)

The Holy Spirit in the Three-Self
Movement: Exploring Ding
Guangxun's Pneumatology

11:00 AM—11:40 AM

Jong Bok Park

(Southwestern Baptist Theological
Seminary)

Korean Pneumatology in the
Hermeneutic Process of Scripture

P 8:30 AM-11:40 AM

Baptist Studies

Baptists and the Holy Spirit

Tower Building – Mezzanine Level
Century

Moderator: Chris Chun
(Gateway Seminary)

8:30 AM—9:10 AM

Matthew Pinson

(Welch College)

The Holy Spirit in Seventeenth-
Century General Baptist Theology

9:20 AM—10:00 AM

Dustin Bruce

(University of Mobile)

The Grand Encouragement: Andrew
Fuller's Evangelical Doctrine of the
Holy Spirit

10:10 AM—10:50 AM

Mark DeVine

(Beeson Divinity School)

Promising the Impossible: Baptist
Church Covenants and Dependence on
the Holy Spirit

11:00 AM—11:40 AM

Earl Waggoner

(Colorado Christian University)

From Filioque to the Force: Is There a
Holy Spirit Identity Crisis Among
Baptists?

P 8:30 AM-11:40 AM

Biblical Worship

Tower Building – Terrace Level

Beverly

Moderator: Scott Aniol

(Southwestern Baptist Theological
Seminary)

8:30 AM—9:10 AM

W. David O. Taylor

(Fuller Theological Seminary)

The "New Song" of the Psalter as a
Model for "Traditioned Innovation" in
Worship

9:20 AM—10:00 AM

G. K. Beale

(Westminster Theological Seminary
(Philadelphia))

Col. 3:16: The Psalms as the Word of
Christ and Inspired by the Spirit

10:10 AM—10:50 AM

David J. Calvert

(Southeastern Baptist Theological
Seminary)

Liturgical Speech Acts in the Lord's
Supper

11:00 AM—11:40 AM

Zachary Jones

(Southeastern Baptist Theological
Seminary)

Recognizing Revelation: The Missing
Biblical and Cultural Component of
the Worship Paradigm

P 8:30 AM-11:40 AM

Bioethics

Theological Anthropology in
Bioethics

Tower Building – Mezzanine Level
Gold

Moderator: John Kilner

(Trinity Evangelical Divinity School)

8:30 AM—9:10 AM

Derek McAllister

(Baylor University)

Reclaiming *Telos* in Mental Health

9:20 AM—10:00 AM

Laura Barwegen

(Wheaton College)

An Evangelical Tent for
Neurobiology?

Wednesday, November 14 8:30 AM – 11:40 AM

10:10 AM—10:50 AM

Brent Waters

(Garrett-Evangelical Theological Seminary)
Disembodied Bioethics

11:00 AM—11:40 AM

Panel Discussion

P 8:30 AM-11:40 AM

Christian History and Thought since 1700

The Oxford Movement and Evangelicalism: Then and Now

Tower Building – Mezzanine Level
Spruce

Moderator: **Karin Stetina**
(Biola University)

8:30 AM—9:10 AM

Michael J McClymond

(Saint Louis University)
Anglo-Catholic or Anglo-Orthodox?:
The Evangelical Significance of a
Neglected Distinction

9:20 AM—10:00 AM

Heber Campos, Jr.

(Andrew Jumper Graduate Center)
Can Newman's essay on doctrinal
development be appropriated by
evangelicals?

10:10 AM—10:50 AM

Mark R Stevenson

(Emmaus Bible College)
Spurgeon, Darby, and the Oxford
Movement: Dissenting Voices in the
Post-1864 Period

P 8:30 AM-11:40 AM

Ecclesiology

Ecclesiological Contextualization
in North America

Tower Building – Terrace Level
Biltmore

Moderator: **Greg Peters**
(Biola University)

8:30 AM—9:10 AM

John Hammett

(Southeastern Baptist Theological Seminary)
The Ecclesiology of 9 Marks
Ministries

9:20 AM—10:00 AM

Gary VanderPol*

(Church without Walls, Berkeley, CA)
Missional *Koinonia*: Retrieval and
Renewal among Secularized Urban
Professionals

10:10 AM—10:50 AM

Stephen Witmer

(Pepperell Christian Fellowship, Pepperell, MA)
Developing a Theological Vision for
Rural/Small-town Ministry

11:00 AM—11:40 AM

Keith Hyde

(University College of the North,
Manitoba, Canada)
Rescue the Parishing: Rev. Henry
Budd – Cree Bridge-builder or Tool
of the British Empire?

P 8:30 AM-11:40 AM

Expository Preaching and Hermeneutics

The Spirit's Distinctive Ministry:
in the OT Believer, Ministry of
Jesus, and NT Saint

Tower Building – Mezzanine Level
Silver

Moderator: **Eric C. Redmond**
(Moody Bible Institute)

8:30 AM—9:10 AM

Walter Kaiser

(Gordon-Conwell Theological Seminary)
The Indwelling of the Holy Spirit in
the Lives of the Old Testament
Believers

9:20 AM—10:00 AM

Bruce A. Ware

(Southern Baptist Theological Seminary)
The Holy Spirit in the Life and
Ministry of Jesus

10:10 AM—10:50 AM

Elliott Johnson

(Dallas Theological Seminary)
The Holy Spirit as the Inheritance
sent from the Ascended Christ

11:00 AM—11:40 AM

Panel Discussion

The Ministry of the Holy Spirit Then
and Now

P 8:30 AM-11:40 AM

General Epistles

Typology in the Book of Hebrews
Tower Building – Terrace Level
Capitol

Moderator:

Herbert W. Bateman IV
(Cyber-Center for Biblical Studies)

8:30 AM—9:10 AM

Buist M. Fanning

(Dallas Theological Seminary)
Typology in the Book of Hebrews

*Invited Guest of ETS

Wednesday, November 14 8:30 AM – 11:40 AM

9:20 AM—10:00 AM

Respondent: Ardel B. Caneday
(University of Northwestern—St. Paul)

10:10 AM—10:50 AM

Respondent:

James M. Hamilton Jr.
(Southern Baptist Theological Seminary)

11:00 AM—11:40 AM

Panel Discussion

P 8:30 AM-11:40 AM

Hebrew Language

Teaching Intermediate Hebrew
and Hebrew Exegesis

Plaza Building – Concourse Level
Governor's Square 9

Moderator: John C. Beckman
(Bethlehem College & Seminary)

8:30 AM—9:10 AM

Russell T. Fuller

(Southern Baptist Theological Seminary)
Using Composition to Learn Biblical
Hebrew Syntax

9:20 AM—10:00 AM

Lee M. Fields

(Mid-Atlantic Christian University)

Fourth-Semester Hebrew: A
Communicative Approach

10:10 AM—10:50 AM

H. H. Hardy II

(Southeastern Baptist Theological
Seminary)

Exegetical Word Studies:
Understanding Genesis through
Leah's "Weak" Eyes

11:00 AM—11:40 AM

Mark Futato

(Reformed Theological Seminary –
Orlando)
Accents and Exegesis: A Guide for the
Perplexed

P 8:30 AM-11:40 AM

**Method in Systematic
Theology**

How Global Can Evangelical

Theology Be? Exploring

Kärkkäinen's Project

Tower Building – Terrace Level
Columbine

Moderator:

Kurt Anders Richardson
(Graduate Institute of Applied
Linguistics)

8:30 AM—9:00 AM

Sung Wook Chung

(Denver Seminary)
Trinity and Revelation

9:00 AM—9:30 AM

John C. Peckham

(Andrews University)
Christ and Reconciliation

9:35 AM—10:05 AM

Daniel Castelo*

(Seattle Pacific University and Seminary)
Creation and Humanity

10:05 AM—10:35 AM

Peter Heltzel

(New York Theological Seminary)
Hope and Community

10:40 AM—11:10 AM

Amos Yong*

(Fuller Theological Seminary)
Spirit and Salvation

11:10 AM—11:40 AM

Veli-Matti Kärkkäinen*

(Fuller Theological Seminary)
Learning from Readers of this Global
Theology

P 8:30 AM-11:40 AM

**New Testament Greek
Language and Exegesis**

Plaza Building – Concourse Level
Governor's Square 12

Moderator: Martin M. Culy
(Cypress Hills Ministries)

8:30 AM—9:10 AM

Christopher D. Land

(McMaster Divinity College)

Francis G. H. Pang

(McMaster Divinity College)

Open Tools for Open Annotation:
OpenText.org Resources for
Analyzing and Teaching Greek

9:20 AM—10:00 AM

Chris S. Stevens

(McMaster Divinity College)
The Orthodox Corruption of
Propositions: Grammar, Theology, or
Evangelical Ideology?

10:10 AM—10:50 AM

David I. Yoon

(McMaster Divinity College)
Speech Functions and Speech Acts:
An Examination of the Tenor of
Galatians 1:6-12

11:00 AM—11:40 AM

Bill Mounce

(BiblicalTraining.org)
Are Literal Translations More
Respectful of the Holy Spirit's Work
in Inspiration?

*Invited Guest of ETS

Wednesday, November 14 8:30 AM – 11:40 AM

P 8:30 AM-11:40 AM

Old Testament Backgrounds / Ancient Near East

Cultic Law in the Old Testament and Ancient Near East

Plaza Building – Concourse Level
Governor's Square 14

Moderator: Dave Deuel
(Master's Academy International/
Christian Institute on Disability)

8:30 AM—9:10 AM

Richard E. Averbeck

(Trinity Evangelical Divinity School)
Mesopotamian Cult: Sumerian and
Akkadian

9:20 AM—10:00 AM

James K. Hoffmeier*

(Trinity Evangelical Divinity School)
Priests and Priesthood According to
the Laws (?), Traditions and Practices
of Ancient Egypt

10:10 AM—10:50 AM

Robert Marineau

(The University of Chicago)
The Cultic Law of the Hittites?
Religious Sources, Practices, and their
Impetus

11:00 AM—11:40 AM

Jim Greenberg

(Denver Seminary)
Priestly Cultic Law (Lev 1-16): The
History of Interpretation in light of
the Comparative Method

P 8:30 AM-11:40 AM

Old Testament Prophetic and Apocalyptic Books

Zephaniah -Malachi

Plaza Building – Concourse Level
Governor's Square 11

Moderator: Paul Wegner
(Gateway Seminary)

8:30 AM—9:10 AM

Richard Schultz

(Wheaton College)
Trinitarian Foundations in the Book
of Isaiah: Can Jesus be identified with
YHWH?

9:20 AM—10:00 AM

Byron G. Curtis

(Geneva College)
The Puzzle of Zechariah 9:13 and the
"Sons of Greece": Assessing Historical
Reconstructions

10:10 AM—10:50 AM

J. Michael Thigpen

(Talbot School of Theology / Biola
University)
The Storm of the Lord: Jeremiah's
Window into the Heart of YHWH

11:00 AM—11:40 AM

Kyle C. Dunham

(Detroit Baptist Theological Seminary)
Zechariah 11 and Eschatological
Shepherds: The Literary Structure as
Clue to a Messianic Reading

P 8:30 AM-11:40 AM

Pastoral Epistles

Tower Building – Majestic Level
Savoy

Moderator: Ray Van Neste
(Union University)

8:30 AM—9:10 AM

Terry Wilder

(Southwestern Baptist Theological
Seminary)
A Pauline Theology of the Holy Spirit
in the Letters to Timothy and Titus

9:20 AM—10:00 AM

Jeff Cockrell

(Welch College)
The Good Deposit in 2 Timothy: Its
Content and Trust

10:10 AM—10:50 AM

L. Timothy Swinson

(Liberty University)
1 Timothy as a Matrix for the
'Lawful' Use of the Law

11:00 AM—11:40 AM

David Chapman

(Covenant Theological Seminary)
The Pastoral Epistles and the Legacy
of the *Hauptbriefe* Discussion

P 8:30 AM-11:40 AM

Paul's Letter to the Romans The Gospel, Sin, and Salvation

Tower Building – Majestic Level
Majestic Ballroom

Moderator: Thomas R. Schreiner
(Southern Baptist Theological Seminary)

8:30 AM—9:00 AM

Robert W. Yarbrough

(Covenant Theological Seminary)
The Centrality of the Gospel in
Romans

9:00 AM—9:30 AM

Douglas Moo

(Wheaton College)
The Meaning of God's Righteousness
in Romans

9:30 AM—9:45 AM

Patrick Schreiner

(Western Seminary)
The Meaning of εὐαγγέλιον: Lexical
and Tradition-historical Explorations

*Invited Guest of ETS

Wednesday, November 14 8:30 AM – 11:40 AM

9:45 AM—10:00 AM

Discussion

10:10 AM—10:40 AM

Mark Seifrid

(Concordia Seminary)

The Revelation of God's Wrath in Romans

10:40 AM—11:10 AM

Robert Gagnon*

(Pittsburgh Theological Seminary)

Paul's Understanding of Same Sex Relations in Romans 1

11:10 AM—11:25 AM

Chris Bruno

(Bethlehem College & Seminary)

God's Grace and Israel's Righteousness in Early Judaism and in Romans

11:25 AM—11:40 AM

Discussion

P 8:30 AM-11:40 AM

Pentateuch

Kingship in the Pentateuch

Plaza Building – Concourse Level
Governor's Square 16

Moderator: Benjamin J. Noonan

(Columbia International University)

8:30 AM—9:10 AM

Peter J. Gentry

(Southern Baptist Theological Seminary)

The Imago Dei and Its Relation to Humanity as God's Vice-Regents on Earth

9:20 AM—10:00 AM

Tremper Longman

(Westmont College)

The Promise of Kingship to the Patriarchs: Is Israel Included?

10:10 AM—10:50 AM

Gary Schnittjer

(Cairn University)

The Blessing of Judah as a Breeding Ground for Scriptural Expectations

11:00 AM—11:40 AM

Jerry Hwang

(Singapore Bible College)

"The King Whom Yahweh Your God Chooses": Deuteronomic Kingship in a World of Sacral Kingship

P 8:30 AM-11:40 AM

Reformation Studies

A Symposium on the 400th Anniversary of Dort

Tower Building – Mezzanine Level
Denver

Moderator: David W. Hall

(Midway Presbyterian Church)

8:30 AM—9:05 AM

Joel Beeke

(Puritan Reformed Theological Seminary)

The Canons of Dort's Promotion of Reformed Experiential Preaching

9:10 AM—9:50 AM

W. Robert Godfrey*

(Westminster Seminary California)

The Synod of Dort: Saving the Reformation

9:55 AM—11:40 AM

Dort's Reception Among the Reformed

9:55 AM—10:20 AM

Matthew Scott Harding

(The WELL - A Community Church)

A Voice Among the Restricted French Delegates of Dort; Pierre Du Moulin on Predestination

10:20 AM—10:50 AM

Martin Klauber

(Trinity International University)

Pierre du Moulin and the Acceptance of the Canons of Dort in France

10:55 AM—11:20 AM

Daniel Borvan

(Oxford University)

Pierre du Moulin's Use of Scripture and Tradition in the Arminian Controversy

11:20 AM—11:40 AM

Panel Response

Joel Beeke

(Puritan Reformed Theological Seminary)

W. Robert Godfrey*

(Westminster Seminary California)

Chad Van Dixhoorn

(Westminster Theological Seminary)

P 8:30 AM-11:40 AM

Spiritual Formation / Sanctification

Spiritual Formation, Spirit & Virtue

Tower Building – Majestic Level
Vail

Moderator: John Coe

(Institute for Spiritual Formation, Talbot School of Theology)

8:30 AM—9:10 AM

Jeff Dryden

(Covenant College)

The Beatitudes as a Model for Spiritual Formation

9:20 AM—10:00 AM

John Coe

(Institute for Spiritual Formation, Talbot School of Theology)

*Invited Guest of ETS

Wednesday, November 14 8:30 AM – 11:40 AM

Two Paths to Experiencing the Spirit:
Pauline Elation and Weakness in 2
Cor. 12

10:10 AM—10:50 AM

Donald S. Whitney
(Southern Baptist Theological Seminary)
Pursuing the Sealing of the Spirit: The
Personal Piety of D. Martyn Lloyd-
Jones

11:00 AM—11:40 AM

Judy TenElshof
(Talbot School of Theology/Biola
University)
Integrating Soul Care Into
Discipleship

P 8:30 AM-11:40 AM

Wesleyan Studies

Sanctification

Tower Building – Mezzanine Level
Colorado

Moderator: Charles White
(Spring Arbor University)

8:30 AM—9:10 AM

Michael Allen
(Reformed Theological Seminary)
Remarks on his new book,
Sanctification: New Studies in
Dogmatics

9:20 AM—10:00 AM

Panel Discussion:
A Wesleyan Response to
Sanctification: New Studies in
Dogmatics

Philip Brown
(God's Bible School and College)

Jerome Van Kuiken
(Oklahoma Wesleyan University)

Thomas McCall
(Trinity Evangelical Divinity School /
University of St Andrews)

10:10 AM—10:50 AM

Matt Friedeman
(Wesley Biblical Seminary)
Applying the Portraits of God

11:00 AM—11:40 AM

Steve Blakemore*
(Wesley Biblical Seminary)
The Holy Spirit in a Holy Church:
Toward a Wesleyan Ecclesiology

A 8:30 AM-11:40 AM

Evangelical Philosophical Society C1

Tower Building – 2nd Floor
Tower Court B

Moderator: R. Keith Loftin
(Southwestern Baptist Seminary)

8:30 AM—9:10 AM

Francis J. Beckwith
(Baylor University)
Why Jews, Christians, and Muslims
Worship the Same God

9:20 AM—10:00 AM

Richard Davis
(Tyndale University)
From Parts to Whole (and Back
Again): Rowe on Clarke on the
Cosmological Argument

10:10 AM—10:50 AM

Patrick Brown
(University of Edinburgh)
(Hyper)Enduring to the End: A Block
Universe Argument against Christian
Eschatology and a Hypertime
Solution

11:00 AM—11:40 AM

Sarah C. Geis
(Denver Seminary)
The Cartesian Ontological Argument:
A Tale of Two Versions, and an
Atypical Harmonization

A 8:30 AM-11:40 AM

Evangelical Philosophical Society C2

Tower Building – 2nd Floor
Tower Court C

Moderator: Anthony Bryson
(Arizona Christian University)

8:30 AM—9:10 AM

Stephanie Nicole Nordby
(University of St Andrews)
Divine Predication, Direct Reference,
and Doctrine

9:20 AM—10:00 AM

Joe Gorra
(Veritas life Center)
How 'Contentment' Figures in a
Willardian Account of Human
Flourishing

10:10 AM—10:50 AM

Tien-Chun Lo
(Oxford University)
A Reply to Speaks's Challenge to
Perfect Being Theology

11:00 AM—11:40 AM

Randy Everist
(University of Birmingham)
How the Divine Interaction Problem
Might be Solved: A Causal Powers
Ontology and God

A 8:30 AM-11:40 AM

Evangelical Philosophical Society C3

Like A Pelting Rain: The Parting
of the Holy Spirit from the West
Tower Building – 2nd Floor
Tower Court D

*Invited Guest of ETS

Wednesday, November 14 8:30 AM – 11:40 AM

Moderator: Angus J.L. Menuge
(Concordia University Wisconsin)

8:30 AM—8:40 AM

Angus Menuge
(Concordia University Wisconsin)
Introduction to panel and panelists

8:40 AM—9:10 AM

Roland C. Ehlke
(Concordia University Wisconsin)
Like a Pelting Rain

9:10 AM—9:40 AM

John Warwick Montgomery
(International Academy of Apologetics)
Four Pneumatological Issues for
Philosophical and Theological
Reflection

9:40 AM—10:10 AM

J. P. Moreland
(Talbot School of Theology)
Scientism and Secularism

10:10 AM—10:40 AM

Kevin Voss
(Concordia University Wisconsin)
The Impact of Secularism on
Bioethics

10:50 AM—11:10 AM

Discussion between panelists

11:10 AM—11:40 AM

Questions from the Floor

A 8:30 AM-11:40 AM

Evangelical Philosophical Society C4

*Panel on Responsible Belief: A
Theory in Ethics and
Epistemology*

Plaza Building – Concourse Level
Plaza Ballroom

Panelists:

Rik Peels
(Vrije Universiteit Amsterdam)

Doug Geivett
(Biola University)

Dave Baggett
(Liberty University)

Robert Larmer
(University of New Brunswick)

Jonathan Loose
(Heythrop College)

A 8:30 AM-11:40 AM

Near East Archaeological Society C

*Season Site Reports and
Excavation Results, Part 1*

Plaza Building – Concourse Level
Governor's Square 17

Moderator: Donald McNeeley
(Tidewater Bible College)

8:30 AM—9:10 AM

Scott Stripling
(The Bible Seminary)
ABR's Second Season at Shiloh - 2018

9:20 AM—10:00 AM

Avraham Faust
(Bar-Ilan University)
The Birth, Life and Death of a Four-
Room House at Tel 'Eton, Israel

10:10 AM—10:50 AM

Avraham Faust
(Bar-Ilan University)
The Resettlement of the Shephelah
during the Iron Age IIA and the
United Monarchy

11:00 AM—11:40 AM

Dale Manor
(Harding University)
Tel Achzib ('tel of deception'):
Observations after Digging for Ten
Years at a Fake Site

T 8:30 AM-11:40 AM

Holy Spirit - Old Testament General Studies 2

Plaza Building – Concourse Level
Plaza Court 6

Moderator: David Casas
(Luther Rice College & Seminary)

8:30 AM—9:10 AM

Richard M. Davidson
(Andrews University)
The Spirit's Work among the
Antediluvians—What, Why, and
When? Three Crucial Issues in Gen 6:3

9:20 AM—10:00 AM

Joshua M. Philpot
(Houston Baptist University)
The Giving of the Spirit as the
Fulfillment of the Abrahamic Promise

10:10 AM—10:50 AM

Nathan C. Lane
(Palm Beach Atlantic University)
Idols, Prophets and Power: The
Prophethood of Believers in the Book
of Isaiah

11:00 AM—11:40 AM

Timothy M Rucker
(The Catholic University of America)
"And His Spirit Was Troubled":
Towards a Pneumatology of the Book
of Daniel

Wednesday, November 14 8:30 AM – 11:40 AM

T 8:30 AM-11:40 AM

Holy Spirit - Systematic Theology

Evangelism and Apologetics

Plaza Building – Concourse Level
Plaza Court 8

Moderator: Sam Welbaum
(California Baptist University)

8:30 AM—9:10 AM

Adamson Co

(California Baptist University)

Doing Apologetics with the Holy Spirit's Work of Creatio Continua: Some Theological Guidelines

9:20 AM—10:00 AM

Kirk R. MacGregor

(McPherson College)

The Holy Spirit as God the Evangelist in Latin American Pneumatology

10:10 AM—10:50 AM

John Jefferson Davis

(Gordon-Conwell Theological Seminary)

The Spirit and the Glory's Banishment from the Material Creation in Early Modern Science

11:00 AM—11:40 AM

Jeremy R. Benbrooks

(Institut Biblique de la Mission Baptiste Internationale-Togo)

The Exclusivity of the Divine Spirit: How John 14:6 Responds to the Animism of the Kabiye People

T 8:30 AM-11:40 AM

The Holy Spirit, the Power of God, and the Future of Evangelical Theology

Plaza Building – Concourse Level
Plaza Ballroom A/B

Moderator: Owen Strachan
(Midwestern Baptist Theological Seminary)

8:30 AM—8:50 AM

Matthew Barrett

(Midwestern Baptist Theological Seminary)

A Question Never Asked: What do the Attributes of God Have to do With the Holy Spirit?

8:50 AM—9:10 AM

J. Ligon Duncan

(Reformed Theological Seminary)

The Spirit's Power Displayed in Revelation

9:15 AM—9:35 AM

Gerald McDermott*

(Beeson Divinity School)

The Whole Earth is Full of His Glory: God's Revelation in Creation

9:35 AM—9:55 AM

R. Albert Mohler Jr.

(Southern Baptist Theological Seminary)

The Spirit's Power Displayed in Christology

10:00 AM—10:20 AM

Erik Thoennes

(Talbot School of Theology/Biola University)

The Spirit's Power Displayed in Soteriology

10:20 AM—10:40 AM

Owen Strachan

(Midwestern Baptist Theological Seminary)

The Spirit's Power Displayed in Ecclesiology

10:50 AM—11:40 AM

Panel Discussion

D 8:30 AM-11:40 AM

Church History

17th-18th Century

Plaza Building – Concourse Level
Plaza Court 7

Moderator: Jonathan S. Marko
(Cornerstone University)

8:30 AM—9:10 AM

Jenny-Lyn de Klerk

(Midwestern Baptist Theological Seminary)

The Puritans on Public Worship in the Local Church: A Deeper Look into Love, Peace, and Unity

9:20 AM—10:00 AM

David Mark Rathel

(University of St Andrews)

Neither Arian Nor Athanasian: A Fresh Consideration of the Trinitarian Theology of Isaac Watts

10:10 AM—10:50 AM

Frankie J. Melton, Jr.

(North Greenville University)

The Ministry of John Marrant: The African-American Whitefield and First Black Preacher in America

11:00 AM—11:40 AM

Jonathan S. Marko

(Cornerstone University)

John Locke, Scripture, and the Problem of Miracles

D 8:30 AM-11:40 AM

New Testament

Pauline Literature 1

Plaza Building – Lobby Level
Director's Row E

Moderator: David W. Hester
(Kearley Graduate School Of Theology, Faulkner University)

Wednesday, November 14 8:30 AM – 11:40 AM

8:30 AM—9:10 AM

Vinh T. Nguyen
(McMaster Divinity College)

Paul and the Kingdom Program: CDA
as Interlocutor for Biblical Studies
and Systematic Theology

9:20 AM—10:00 AM

Timothy Howe
(Midwestern Baptist Theological
Seminary)

God's Cosmic King: The Meaning of
"The Image of God" in Paul

10:10 AM—10:50 AM

Darlene M. Seal
(McMaster Divinity College)
Negotiating Christian Identity: A
Social Identity Analysis of Paul's
Strategy in 1 Cor 10:1-22

11:00 AM—11:40 AM

Kevin L. Moore
(Freed-Hardeman University)
"We" Language and Pauline
Authorship

D 8:30 AM-11:40 AM

Practical Theology

Pastoral Leadership

Plaza Building – Concourse Level
Governor's Square 10

Moderator: Simon Knighten
(McMaster Divinity College)

8:30 AM—9:10 AM

Shane W. Parker
(Southern Baptist Theological Seminary)
"The Eagle Wing of Imagination:"
Methods for Vivid Writing in the
Works of Thomas Brooks

9:20 AM—10:00 AM

Maurice Elliott
(Church of Ireland Theological Institute/
Trinity College Dublin)

Preaching and Leadership: The
Interfacing of Critical Styles and
Features.

10:10 AM—10:50 AM

Michael S. Wilder
(Southern Baptist Theological Seminary)
Brothers Raised Up Among Brothers:
Pastoral Leader as a Fellow Follower

11:00 AM—11:40 AM

Todd Wilson
(Center for Pastor Theologians)
The Cruciform Theologian:
Reflections on the Epistemology of
Pastoral Suffering

D 8:30 AM-11:40 AM

Systematic Theology

Anthropology

Plaza Building – Concourse Level
Governor's Square 15

Moderator: Timothy J. Kleiser
(Boyce College)

8:30 AM—9:10 AM

Fellipe do Vale
(Southern Methodist University)
Cappadocian or Augustinian?
Adjudicating Debates on Gender in
the Resurrection

9:50 AM—10:30 AM

Robert S. Smith
(Sydney Missionary & Bible College)
Sex and (Trans)Gender in Biblical
Perspective

10:10 AM—10:50 AM

James M. Arcadi
(Trinity Evangelical Divinity School)
Homo Adorans: Exitus – Reditus in
Theological Anthropology

11:00 AM—11:40 AM

Kevin W. Wong
(Wheaton College Graduate School)
Christian Physicalism Is Not Crazy: A
Survey of Contemporary Scholarship

D 8:30 AM-11:40 AM

Systematic Theology

General Studies 1

Tower Building – 2nd Floor
Windows

Moderator: Alan J. Thompson
(Sydney Missionary and Bible College)

8:30 AM—9:10 AM

Ronald M. Rothenberg
(Independent Researcher)
The Necessity of Heresy: The
Continuing Importance of Heresy and
Orthodoxy

9:20 AM—10:00 AM

Mark L. Strauss
(Bethel Seminary San Diego)
A Review of the Christian Standard
Bible (CSB)

10:10 AM—10:50 AM

Ched Spellman
(Cedarville University)
What Remains of Edith Finch and the
Function of Lament in the Christian
Life

11:00 AM—11:40 AM

John DelHousaye
(Phoenix Seminary)
Jeff Purswell
(Sovereign Grace Churches)

John Hughes
(P&R Publishing)
Scripture and the People of God: A
Tribute to Wayne Grudem

Wednesday AM – PM

C 8:30 AM-11:40 AM

Mini-Workshop for Early-Career Faculty on Assessing Teaching and Learning

Plaza Building – Lobby Level
Director's Row J

Moderator: Paul Myhre*
(Wabash Center)

8:30 AM—9:10 AM

Paul Myhre*
(Wabash Center)

Course: How to assess your course as a whole, including how to create and assess student learning outcomes

9:20 AM—10:00 AM

C. Ryan Griffith
(The Gospel Coalition)

Classroom: How to assess what the students are learning in your classroom sessions

10:10 AM—10:50 AM

Timothy A. Gabrielson
(Sterling College)

Grading: How to assess the evidence for learning in student assignments, such as papers

11:00 AM—11:40 AM

Jacob Shatzer
(Union University)

Mission: How to assess how your course aligns with and advances the mission of your particular institution

11:45 AM - 12:45 PM

NEAS Business Meeting

Plaza Building – Concourse Level
Governor's Square 17

11:45 AM - 12:45 PM

Lunch Break

1:00 PM - 1:50 PM

ETS Plenary Session II

Plaza Building – Concourse Level
Plaza Ballroom

Craig S. Keener
(Asbury Theological Seminary)
The Spirit and the Mission of the Church

2:00 PM - 2:50 PM

EPS Plenary Session

Plaza Building – Concourse Level
Plaza Ballroom

William Lane Craig
(Talbot School of Theology)
In Defense of Penal Substitution

P 3:00 PM-6:10 PM

Applied Linguistics and Biblical Languages

Facilitating Learning Outside the Classroom

Tower Building – Terrace Level
Capitol

Moderator: Lee M. Fields
(Mid-Atlantic Christian University)

3:00 PM—3:40 PM

Jennifer Noonan
(Columbia International University)

Scott McQuinn
(Biblical Language Center)

Teaching Biblical Languages Communicatively in an Online Environment

3:50 PM—4:30 PM

Brian Schultz
(Fresno Pacific University)
Teaching Reading Comprehension Outside the Classroom

4:40 PM—5:20 PM

Jesse Scheumann
(Bethlehem College & Seminary)
Justus Witmer
(Bethlehem College & Seminary)
Storytelling as the Basis for Language-Production Homework

5:30 PM—6:10 PM

Randall Buth
(Institute for Biblical Languages and Translation / Biblical Language Center)
TOBHFL: Providing A Standardized, Language-neutral Test of Biblical Hebrew

P 3:00 PM-6:10 PM

Biblical Worship

Plaza Building – Lobby Level
Director's Row J

Moderator: Robert Pendergraft
(University of Mary Hardin – Baylor)

3:00 PM—3:40 PM

Timothy Ralston
(Dallas Theological Seminary)
The Ambiguity of "in spirit": Addressing Disparate Approaches

3:50 PM—4:30 PM

James M. Hamilton Jr.
(Southern Baptist Theological Seminary)

*Invited Guest of ETS

Wednesday, November 14 3:00 PM – 6:10 PM

The Holy Spirit in Christian Worship:
The Life-giving Legacy of the
Apostolic Band

4:40 PM—5:20 PM

Scott Aniol

(Southwestern Baptist Theological
Seminary)

The Holy Spirit's Work in Worship:
Extraordinary Experience or
Disciplined Formation?

5:30 PM—6:10 PM

Panel Discussion:

The Holy Spirit and Worship

P 3:00 PM-6:10 PM

Bioethics

Plaza Building – Concourse Level
Plaza Court 6

Moderator: Brad Mellon
(Bethel Seminary)

3:00 PM—3:40 PM

Cristina Richie

(East Carolina University)

Climate Change Related Health
Hazards and the Academic
Responsibility of Theological
Bioethics

3:50 PM—4:30 PM

Mark J. Farnham

(Lancaster Bible College)

How Far Will We Go to Save Lives?
The Medical Ethics of Organ
Transplantation

4:40 PM—5:20 PM

Michael Cox

(Trinity Evangelical Divinity School)

From Life-Ethic to Bioethics: A
Paradigmatic Approach to
Deuteronomy's Appeal to Life

5:30 PM—6:10 PM

Dieumeme Noelliste*

(Denver Seminary)

Caring for Life: A Covenantal and
Ethico-Eschatological Perspective

P 3:00 PM-6:10 PM

Christian History and Thought since 1700

The Oxford Movement and
Evangelicalism: Then and Now

Plaza Building – Concourse Level
Governor's Square 16

Moderator: Jennifer McNutt
(Wheaton College)

3:00 PM—3:40 PM

Ken Stewart

(Covenant College)

The Oxford Movement and
Evangelicalism: Initial Encounters

3:50 PM—4:30 PM

Timothy Larsen

(Wheaton College)

The Oxford Movement and the
Scriptures: The 19th Century
Trajectory

4:40 PM—5:20 PM

Andrew Atherstone*

(Wycliffe Hall, University of Oxford)

Bishop J.C. Ryle and the Oxford
Movement

5:30 PM—6:10 PM

Panel Discussion

P 3:00 PM-6:10 PM

Christianity and Culture

A Conversation with Philip Yancey

Tower Building – 2nd Floor

Grand Ballroom II

Moderator: Glenn R. Kreider
(Dallas Theological Seminary)

Philip Yancey*

Things I've Figured out (I Think)

Responses:

R. Todd Mangum

(Biblical Theological Seminary)

Glenn R. Kreider

(Dallas Theological Seminary)

Philip Yancey*

Things that Disturb Me

Responses:

John Adair

(Dallas Theological Seminary)

Steve Sherman

(Grand Canyon University, College of
Theology)

Philip Yancey*

Things I Haven't Figured Out

Responses:

M. Todd Bates

(Houston Baptist University)

Earl Waggoner

(Colorado Christian University)

Audience Interaction with Phillip
Yancey

P 3:00 PM-6:10 PM

Hermeneutics

The Role of the Holy Spirit in
Christian Interpretation of
Scripture

Plaza Building – Concourse Level
Governor's Square 12

Moderator: W. Edward Glenny
(University of Northwestern - St. Paul)

*Invited Guest of ETS

Wednesday, November 14 3:00 PM – 6:10 PM

3:00 PM—3:20 PM

Craig S. Keener

(Asbury Theological Seminary)

3:20 PM—3:40 PM

Tamra J. Hernandez

(Fort Worth, Texas)

3:50 PM—4:10 PM

Paul Wegner

(Gateway Seminary)

4:10 PM—4:30 PM

J. Scott Duvall

(Ouachita Baptist University)

4:40 PM—5:20 PM

Panel Discussion

5:30 PM—6:10 PM

Question and answer time with the audience

P 3:00 PM-6:10 PM

Inerrancy of Scripture

Inerrancy in the Life of the Church

Plaza Building – Concourse Level
Governor's Square 14

Moderators:

Robert W. Yarbrough

(Covenant Theological Seminary)

Gregg Allison

(Southern Baptist and Southeastern Baptist Theological Seminary)

J. Michael Thigpen

(Talbot School of Theology / Biola University)

3:00 PM—3:40 PM

Michael A. G. Haykin

(Southern Baptist Theological Seminary)
Scriptural Inerrancy: The Witness of Andrew Fuller

3:50 PM—4:30 PM

Dana M. Harris

(Trinity Evangelical Divinity School)

"Today If You Hear My Voice": The Spirit and the Ongoing Testimony of God's Word in Hebrews

4:40 PM—5:20 PM

Sydney Park

(Beeson Divinity School)

Inerrancy & Blood: Women and Christology in Leviticus 12, 15 and Mark 5:21-43

5:30 PM—6:10 PM

John Fesko

(Westminster Seminary California)

Charles Briggs, Revelation, and Worshipers of the Sacred Fire: Nineteenth Century Challenges to Inerrancy

P 3:00 PM-6:10 PM

Islam & Evangelical Christianity

Religious Liberty: Does Religious Freedom for One Mean Religious Freedom for All?

Plaza Building – Concourse Level
Governor's Square 15

Panelists:

Darrell Bock

(Dallas Theological Seminary)

R. Albert Mohler Jr.

(Southern Baptist Theological Seminary)

Ayman Ibrahim

(Southern Baptist Theological Seminary)

Joseph Cumming

(International Church at Yale)

Jennifer Bryson*

(Religious Freedom Institute)

C. Donald Smedley

(Rivendell Institute at Yale University)

P 3:00 PM-6:10 PM

Letter to the Hebrews

Currents and Rapids in Hebrews' Scholarship

Tower Building – Mezzanine Level
Century

Moderator: Jon Laansma

(Wheaton College)

3:00 PM—3:40 PM

Chee-Chiew Lee

(Singapore Bible College)

The Use of Scripture and the Rhetoric of Fear in Hebrews

3:50 PM—4:30 PM

Bryan Dyer

(Baker Academic/Calvin College)

Faith in the Face of Death: Hebrews 11 and its Rhetorical Strategy

4:40 PM—5:20 PM

Ben Ribbens

(Trinity Christian College)

"Sacrifice and Offering You Did Not Desire": Psalm 40:6 – 8 in Hebrews and the Sacrifice God Desired

5:30 PM—6:10 PM

Bobby Jamieson*

(Capitol Hill Baptist Church)

Something to Offer: Connecting Jesus' Death and Heavenly Offering in Hebrews

P 3:00 PM-6:10 PM

New Testament Canon, Textual Criticism & Apocryphal Literature

Tower Building – Mezzanine Level
Silver

*Invited Guest of ETS

Wednesday, November 14 3:00 PM – 6:10 PM

Moderator: Stanley E. Porter
(McMaster Divinity College)

3:00 PM—3:40 PM

W. Brian Shelton

(Toccoa Falls College)

Apostle Stories after the New Testament: Discerning the Legitimacy of the Apocryphal Acts

3:50 PM—4:30 PM

Peter J. Gurry

(Phoenix Seminary)

A Book 'Worth Publishing': The Making of Westcott & Hort's Monumental Edition of the Greek NT

4:40 PM—5:20 PM

Elijah Hixson

(Tyndale House, Cambridge)

How the Bible Was Copied in the Sixth Century and Why Singular Readings Don't Tell Us That

5:30 PM—6:10 PM

Jonathan C. Borland

(New Orleans Baptist Theological Seminary)

Inspired Editing or Scribal Corruption? Problems in Determining the Final Form of the NT Canon

P 3:00 PM-6:10 PM

Old Testament Narrative

Literature

Narrative Criticism

Tower Building – Terrace Level

Columbine

Moderator: Michael A. Grisanti

(The Master's Seminary)

3:00 PM—3:40 PM

Gary Schnittjer

(Cairn University)

New Version of an Old Infidelity:
Kadesh in Deuteronomy 1

3:50 PM—4:30 PM

Brian Neil Peterson

(Lee University)

'Jacob's Trouble': The Shechem Fiasco and the Breaking of Covenant in Genesis 34

4:40 PM—5:20 PM

Gregory T. K. Wong

(Evangel Seminary, Hong Kong)

Inner-Biblical Allusion: Exegetical and Historical Issues it Can Potentially Address

5:30 PM—6:10 PM

Robert B. Chisholm, Jr.

(Dallas Theological Seminary)

Hannah's Song: Literary Analysis and Canonical Significance

P 3:00 PM-6:10 PM

Old Testament Theology

Canon and Canonical Reading

Plaza Building

Concourse Level — Plaza Court 7

Moderator: Heath A. Thomas

(Oklahoma Baptist University)

3:00 PM—3:40 PM

Ron Haydon

(Wheaton College)

Reconsidering Apocalyptic: A Canonical Reading of Daniel 7

3:50 PM—4:30 PM

D. Jeffrey Mooney

(California Baptist University)

Living in Fear: Unwavering Confidence in the Good and Powerful God of Israel

4:40 PM—5:20 PM

R. Gregg Watson

(Gateway Seminary of the Southern Baptist Convention)

Moses, the Tabernacle and Mount Sinai: Contextualizing the Sinai Event in Terms of Sacred Space

5:30 PM—6:10 PM

Peter Link, Jr.

(Charleston Southern University)

The Land that Moses Shows Us: The Pentateuch's Perspective on the Land for the Reader

P 3:00 PM-6:10 PM

Patristic and Medieval History

The Holy Spirit in Patristic Thought

Tower Building – 2nd Floor

Tower Court A

Moderator: Stefana Dan Laing

(Beeson Divinity School)

3:00 PM—3:40 PM

Brian Matz*

(Fontbonne University)

Patristic Sources and Trinitarian Implications in the Ninth-Century Procession Debates

3:40 PM—4:00 PM

Graydon Cress

(University of St Andrews)

Basil of Caesarea: Champion for the Holy Spirit

4:00 PM—4:20 PM

Jared Bryant

(Cairn University)

The Divinity of the Holy Spirit according to Gregory of Nazianzus and Basil of Caesarea

*Invited Guest of ETS

Wednesday, November 14 3:00 PM – 6:10 PM

4:20 PM—4:30 PM

Discussion

4:30 PM—4:50 PM

Esther Ng

(Christian Witness Theological Seminary)

Montanism: Precursor of the

Contemporary Charismatic

Movement? Feminist Aspirations?

4:50 PM—5:10 PM

Megan DeVore

(Colorado Christian University)

A Post-Montanist Perspective: The

Holy Spirit in a North African

Martyr Account

5:10 PM—5:20 PM

Discussion

5:20 PM—5:40 PM

D. Jeffrey Bingham

(Southwestern Baptist Theological

Seminary)

Christ, the Spirit, and the Water in

Irenaeus

5:40 PM—6:00 PM

Respondent: Brian Matz*

(Fontbonne University)

6:00 PM—6:10 PM

Wrap-up Discussion

P 3:00 PM-6:10 PM

Pauline Studies

Scripture in Romans & 1

Corinthians

Tower Building – Mezzanine Level

Gold

Moderator: Linda Belleville

(Grand Rapids Theological Seminary)

3:00 PM—3:40 PM

Steve Sullivan

(College of Biblical Studies, Houston)

The Isaianic New Exodus Wisdom

Polemic in Romans 9-11

3:50 PM—4:30 PM

Michael T. Graham Jr.

(Bar-Ilan University)

To David? Paul's Use of Composite

Quotations in Romans 3:10-18: Taking

the Context into Account

4:40 PM—5:20 PM

Joshua Heavin*

(Trinity College Bristol)

What is 'Real Participation' in Christ?

Recent Trends and Covenant

Hermeneutics in 1 Corinthians 8-10

5:30 PM—6:10 PM

Stuart Langley

(Southern Baptist Theological Seminary)

Agency and Obduracy: A Comparison

of Romans 11:8 and 1QIsa

P 3:00 PM-6:10 PM

Pentateuch

Plaza Building – Lobby Level

Director's Row H

Moderator: Benjamin J. Noonan

(Columbia International University)

3:00 PM—3:40 PM

Benjamin A. Foreman

(TMU - IBEX)

Centralization in the Pentateuch: Is

Exodus 20:24 – 26 Really at Odds with

Deuteronomy?

3:50 PM—4:30 PM

Daniel Buller

(Southwestern Baptist Theological

Seminary)

Fall or No Fall? On the relationship of

Genesis 2-3 and 4:1-16

4:40 PM—5:20 PM

Mario Tafferfer

(Trinity Evangelical Divinity School)

Heirs in Conflict: The Rivalry

between Cain and Abel in its

Northwest Semitic Background

5:30 PM—6:10 PM

J. Daniel Hays

(Ouachita Baptist University)

The Presence of God in the Book of

Exodus and the Meaning of the Name

Yahweh in Exodus 3 and 6

P 3:00 PM-6:10 PM

Psalms and Hebrew Poetry

Canonical Studies in the Psalms

after Thirty Years

Tower Building – Terrace Level

Terrace

Moderator: Daniel Estes

(Cedarville University)

3:00 PM—3:40 PM

Tremper Longman

(Westmont College)

Assumptions and Antecedents of

Gerald Wilson's Canonical Approach

to the Psalms

3:50 PM—4:30 PM

David M. Howard, Jr.

(Bethel Seminary)

Adopters and Adapters of Gerald

Wilson's Canonical Approach to the

Psalms

4:40 PM—5:20 PM

Jamie Grant*

(Highland Theological College UHI)

Augmentations to Gerald Wilson's

Canonical Approach to the Psalms

*Invited Guest of ETS

Wednesday, November 14 3:00 PM – 6:10 PM

5:30 PM—6:10 PM

Panel Discussion

Assessment of Gerald Wilson's
Canonical Approach to the Psalms

Michael McKelvey

(Reformed Theological Seminary)

Tremper Longman

(Westmont College)

David M. Howard, Jr.

(Bethel Seminary)

Jamie Grant*

(Highland Theological College UHI)

P 3:00 PM-6:10 PM

Reformation Studies

Dort and Westminster (1618-1648)

Tower Building – Mezzanine Level
Spruce

Moderator: David W. Hall

(Midway Presbyterian Church)

3:00 PM—3:30 PM

Iver Martin

(Edinburgh Theological Seminary)

Communion in a Cave: The
Sacramental Liturgy of the Scots at
Westminster

3:30 PM—4:00 PM

Harrison Perkins

(Queen's University Belfast)

James Ussher's Probable Influence on
the Westminster Assembly

4:35 PM—5:05 PM

Panel Response

Chad Van Dixhoorn

(Westminster Theological Seminary)

Greg Salazar

(Puritan Reformed Theological Seminary)

5:10 PM—5:40 PM

James M. Renihan

(IRBS Theological Seminary)

A Question of Orthodoxy: The First
London Baptist Confession and its
Contemporary Critics

5:40 PM—6:10 PM

Stephen Brett Eccher

(Southeastern Baptist Theological
Seminary)

Luther Giveth and Taketh Away:
Martin Luther's Shift Regarding the
Laity's Reading of Scripture

P 3:00 PM-6:10 PM

Septuagint Studies

Tower Building – Mezzanine Level
Denver

Moderator: Jennifer Brown Jones

(McMaster Divinity College)

3:00 PM—3:40 PM

Edmon L. Gallagher*

(Heritage Christian University)

Jerome on the Septuagint as Christian
Scripture

3:50 PM—4:30 PM

Gregory R. Lanier

(Reformed Theological Seminary,
Orlando)

William A. Ross

(University of Cambridge)

How We Produced "Septuaginta: A
Reader's Edition" ... and What We
Learned

4:40 PM—5:20 PM

Christopher J. Fresch

(Bible College of South Australia)

The Septuagint and Discourse
Grammar

5:30 PM—6:10 PM

Zachary A. Vickery

The Translation Technique of LXX-
Ruth

P 3:00 PM-6:10 PM

Spiritual Formation / Sanctification

Spiritual Formation and Holy
Spirit

Tower Building – Majestic Level
Vail

Moderator: John Coe

(Institute for Spiritual Formation, Talbot
School of Theology)

3:00 PM—3:40 PM

Kyle Strobel

(Institute for Spiritual Formation /
Talbot School of Theology)

Jonathan Edwards and the Spirit:
Infusion and Formation

3:50 PM—4:30 PM

Evan B. Howard

(Spirituality Shoppe)

Just What is Christian Spirit-ual
Formation Anyway? A Biblical
Inquiry

4:40 PM—5:20 PM

Laura Barwegen

(Wheaton College)

Intersection Between Neurobiology
and the Holy Spirit

5:30 PM—6:10 PM

Tom Schwanda

(Wheaton College)

George Whitefield's Maturing
Pneumatology: The Privilege and
Power of the Indwelling Spirit

*Invited Guest of ETS

Wednesday, November 14 3:00 PM – 6:10 PM

P 3:00 PM-6:10 PM

Voices in American Theology and Culture: Wendell Berry

Holy People, Holy Land

Plaza Building – Concourse Level

Plaza Court 8

Moderator: Jacob Shatzer

(Union University)

3:00 PM—3:40 PM

Daniel Montgomery

(Leadership Reality Advising / Wheaton College)

Todd Edmondson*

(Milligan College)

Holy Kentucky: Practicing

Membership with Wendell Berry and Thomas Merton

Moderator: Paul R. House

(Beeson Divinity School)

3:50 PM—4:30 PM

Ellen F. Davis*

(Duke Divinity School)

Holy Place: Precious, Fragile, Threatened

4:40 PM—5:20 PM

Panel Discussion:

Holy People, Holy Land: A

Conversation with Ellen F. Davis on Agrarianism in the Old Testament

Moderator: Amy Whitfield

(Southeastern Baptist Theological Seminary)

5:30 PM—6:10 PM

Richard A. Bailey

(Canisius College)

Unholy Wound: Thinking about

"Race" and Membership in the

Writings of Wendell Berry and Ernest

J. Gaines

A 3:00 PM-6:10 PM

Adventist Theological Society

Plaza Building – Lobby Level

Director's Row I

Moderator: John W. Reeve

(Andrews University)

3:00 PM—3:40 PM

Christopher R. Mwashinga

(Andrews University)

Personality and Function of the Holy

Spirit: A Biblical and Theological

Investigation

3:50 PM—4:30 PM

Clinton Wahlen

(Biblical Research Institute)

The Holy Spirit in the Synoptic

Gospels

4:40 PM—5:20 PM

Matthew L. Tinkham Jr.

(Andrews University)

An Exegetical and Intertextual

Exploration of the Presence of the

Spirit in the Colossians

5:30 PM—6:10 PM

Erhard Gallos

(Andrews University)

Hebrews and the Pneumatology of

Pentecost

A 3:00 PM-6:10 PM

Evangelical Philosophical Society D1

Tower Building – 2nd Floor

Tower Court B

Moderator: Liz Jackson

(University of Notre Dame)

3:00 PM—3:40 PM

J.P. Moreland

(Talbot School of Theology)

The Autonomy and Authority Theses and the Failure of Scientism?

3:50 PM—4:30 PM

Gregory E. Ganssle

(Talbot School of Theology)

Nietzsche's Double-Edged Sword: The

Death of God and the Poverty of

Naturalism

4:40 PM—5:20 PM

Gary Habermas

(Liberty University)

Evidenced Near-Death Experiences

Revisited: The Latest Evidence that

Challenges Naturalism

5:30 PM—6:10 PM

David Skowronski

(Baylor University)

The Unrepentant God

A 3:00 PM-6:10 PM

Evangelical Philosophical Society D2

Tower Building – 2nd Floor

Tower Court C

Moderator: Daniel von Wachter

(IAP Liechtenstein)

3:00 PM—3:40 PM

Christopher Woznicki

(Fuller Theological Seminary)

Do We Believe in Consequences?

Revisiting Mark Murphy's

'Incoherence Objection' to Penal

Substitution

*Invited Guest of ETS

Wednesday, November 14 3:00 PM – 6:10 PM

3:50 PM—4:30 PM

Steven B. Cowan

(Lincoln Memorial University)

Aut Abstractum: Idealism and Abstract Objects

4:40 PM—5:20 PM

Kevin W. Wong

(Wheaton College Graduate School)

Christological Implications of Omnisubjectivity

5:30 PM—6:10 PM

Timothy Mosteller

(California Baptist University)

Discovering Existence: Moreland, Stein, and Vallicella Among Some Thomists

A 3:00 PM-6:10 PM

Evangelical Philosophical Society D3

Tower Building – 2nd Floor

Tower Court D

Moderator: Owen Anderson

(Arizona State University)

3:00 PM—4:30 PM

Owen Anderson

(Arizona State University)

Dan Bonevac

(University of Texas)

Kelly Fitzsimmons Burton

(Paradise Valley Community College)

Christian Philosophers in the Secular Academy

Moderator: Jon Kelly

(Biola University)

4:40 PM—5:20 PM

Gary Osmundsen

(Grand Canyon University)

Trinitarian Agency: Knowing God Through Sanctifying Actions

5:30 PM—6:10 PM

Joel Ballivian

(University of Wisconsin)

Design Arguments, Likelihoods, and Total Evidence

A 3:00 PM-6:10 PM

Near East Archaeological Society D

Season Site Reports and

Excavation Results, Part 2

Plaza Building – Concourse Level

Governor's Square 17

Moderator: Donald McNeeley

(Tidewater Bible College)

3:00 PM—3:40 PM

Randall Price

(Liberty University)

Dead Sea Scroll Caves Yield New Discoveries

3:50 PM—4:30 PM

Terrence Nichols

(Southwest Baptist Theological Seminary)

The Likely Resting Place of Herod the Great -A Reply to Patrich and Arubas

4:40 PM—5:20 PM

Mark Wilson

(Stellenbosch University)

Bob Wagner

(Independent Scholar)

Why Derbe? An Unlikely City for Paul's Ministry

5:30 PM—6:10 PM

David H. Vila

(John Brown University)

Abila of the Decapolis: the 2018 Season of Excavation

T 3:00 PM-6:10 PM

Holy Spirit - Systematic Theology

Sanctification

Plaza Building – Lobby Level

Director's Row E

Moderator: Don J. Payne

(Denver Seminary)

3:00 PM—3:40 PM

John McKinley

(Talbot School of Theology)

Spirit Christology as the Model of Christian Spirituality

3:50 PM—4:30 PM

Peter Battaglia

(Marquette University)

The Spirit of Virtue: Investigating the Role of the Holy Spirit in Cultivating Virtue

4:40 PM—5:20 PM

Keith Graham

(Christian Community Churches-Victoria and Tasmania)

The Holy Spirit and Behavior Change

5:30 PM—6:10 PM

Christopher Cleveland

(Orlando Central Baptist Church)

Infused Habits and the work of the Holy Spirit

Wednesday, November 14 3:00 PM – 6:10 PM

T 3:00 PM-6:10 PM

Reflections on Michael Horton's *Rediscovering the Holy Spirit* and the Future of Pneumatology in Dogmatics

Tower Building – 2nd Floor
Windows

Moderators:

Matthew Barrett
(Midwestern Baptist Theological Seminary)

Ronni Kurtz
(Midwestern Baptist Theological Seminary)

3:00 PM—3:30 PM

Fred Sanders
(Biola University)
A Step Back Every Now and Again: Horton's Ordinary Pneumatology

3:30 PM—4:00 PM

Matthew Barrett
(Midwestern Baptist Theological Seminary)
Can it be done? Identifying the Spirit's Role in the Incarnation without Compromising Orthodoxy

4:10 PM—4:40 PM

Stephen Wellum
(Southern Baptist Theological Seminary)
The Spirit in Redemptive History as Illustration of the Relationship between Biblical and Systematic Theology

4:40 PM—5:10 PM

Michael Allen
(Reformed Theological Seminary)
The Gospel and the Catholic Church Reconsidered

5:10 PM—5:40 PM

Respondent: Michael Horton
(Westminster Seminary California)

5:40 PM—6:10 PM

Panel Discussion

D 3:00 PM-6:10 PM

Church History

19th-20th Century

Plaza Building – Concourse Level
Governor's Square 9

Moderator: Richard V. Pierard
(Indiana State University Emeritus / Asheville, NC)

3:00 PM—3:40 PM

Kevin T. Bauder
(Central Baptist Theological Seminary of Minneapolis)
Carl McIntire's Conflict with the American Council of Christian Churches

3:50 PM—4:30 PM

David Setran
(Wheaton College)
"Mother Knows Best:" The Maternal Turn in American Protestant Nurture, 1820-1860

4:40 PM—5:20 PM

Geoffrey Chang
(Midwestern Baptist Theological Seminary)
The Congregationalism of C.H. Spurgeon at the New Park Street Chapel (1854-1861)

5:30 PM—6:10 PM

Paul Sanchez
(Southern Baptist Theological Seminary)
Pentecostalism's Pioneering Doctrine: Charles Parham's theology of Holy Spirit Baptism

D 3:00 PM-6:10 PM

New Testament

Pauline Literature 2

Tower Building – Mezzanine Level
Colorado

Moderator: Jeff Cockrell
(Welch College)

3:00 PM—3:40 PM

David E. Briones
(Reformation Bible College)
The Mind of Christ in the Church: Setting Our Minds on a Neglected Portion of Romans

3:50 PM—4:30 PM

John Goodrich
(Moody Bible Institute)
Rewriting the Defeat of Evil in Qumran and in Ephesians

4:40 PM—5:20 PM

Brian H. Tung
(Trinity Evangelical Divinity School)
"Savior of All People": Distinguishing Universality from Universalism in the Pastoral Epistles

5:30 PM—6:10 PM

Marjorie J. Cooper
(Baylor University)
Analysis and Conclusions Regarding 1 Tim 2:8-3:1a

D 3:00 PM-6:10 PM

Old Testament

Historical Books

Tower Building – Majestic Level
Savoy

Moderator: Randall L. McKinion
(Cedarville University)

Wednesday, November 14 3:00 PM – 6:10 PM

3:00 PM—3:40 PM

Jillian L. Ross

(Liberty University)

The Spirit Rushed and Samson
Hushed: Worship in Judges 15 – 16

3:50 PM—4:30 PM

Seth Postell

(Israel College of the Bible)

Reading the David and Bathsheba
Narrative in Light of the Story of
Joseph and Potiphar's Wife

4:40 PM—5:20 PM

John D. Meade

(Phoenix Seminary)

The Canonicity of Esther in Early
Jewish & Christian Sources: A Case
Study for Evaluating Canon

5:30 PM—6:10 PM

Joshua E. Williams

(Southwestern Baptist Theological
Seminary)

Like Father, Like Son: Uzziah and
Jotham in Chronicles

D 3:00 PM-6:10 PM

Practical Theology

Care and Counseling

Plaza Building – Concourse Level
Governor's Square 11

3:00 PM—3:40 PM

Matthew R. Akers

(Mid-America Baptist Theological
Seminary)

Key Sources of Conflict in
Multiethnic Marriages

3:50 PM—4:30 PM

Paul S. Jeon

(Reformed Theological Seminary D.C.)

The Letter to Philemon: A Model of
Winsome Mediation

4:40 PM—5:20 PM

Philip Stewart

(Martin Luther International Seminary)

PTS, Moral Injury, and the Care of
Souls: Ancient Care for New
Challenges

5:30 PM—6:10 PM

Eric L. Johnson

(Southern Baptist Theological Seminary)

Stephen Dempster

(Crandall University)

"Punish them, Lord"/"Father, forgive
them": Christian Maturation as
Recapitulation of the Canon

D 3:00 PM-6:10 PM

Practical Theology

General Studies 2

Tower Building – Terrace Level
Biltmore

3:00 PM—3:40 PM

Kit Barker

(Sydney Missionary and Bible College)

Forgive as The Lord Forgave You -
Divine Forgiveness as Paradigm

3:50 PM—4:30 PM

Kyunga Song

(Chongshin University)

Christlike Human Forgiveness:
Conditional or Unconditional?

4:40 PM—5:20 PM

James Wilhoit

(Wheaton College)

Self-Compassion as a Christian
Spiritual Practice

5:30 PM—6:10 PM

Malcolm Gill

(Sydney Missionary and Bible College,
Australia)

The Theology & Practice of the
Gospel Invitation in the preaching of
Wesley, Spurgeon, & Graham

D 3:00 PM-6:10 PM

Progressive Covenantalism

Tower Building – Terrace Level
Beverly

Moderator: Brent E. Parker

(Southern Baptist Theological Seminary)

3:00 PM—3:40 PM

Jason S. DeRouchie

(Bethlehem College & Seminary)

For Our Instruction: A Biblical Case
for Christ-Centered Interpretation of
the Old Testament

3:50 PM—4:30 PM

Peter J. Gentry

(Southern Baptist Theological Seminary)

The New Israel in Isaiah – A
Challenge to Covenant and
Dispensational Theologians

4:40 PM—5:20 PM

Ardel B. Caneday

(University of Northwestern—St. Paul)

The True Bridegroom Comes:
Nuptials, Ceremonial Cleansing, and
Wine in John 2 & 3

5:30 PM—6:10 PM

P. Chase Sears

(Southern Baptist Theological Seminary)

The Startling Mystery: Christ and the
Salvation of "All Israel"

Wednesday PM // Thursday AM

D 3:00 PM-6:10 PM

Systematic Theology

General Studies 3

Plaza Building – Concourse Level
Governor's Square 10

Moderator:

Christopher A. Graham
(Criswell College)

3:00 PM—3:40 PM

J. Scott Horrell

(Dallas Theological Seminary)

"Persons" Divine and Human: The
Concept of Person in and Beyond
Nicaea for Today

3:50 PM—4:30 PM

D. Glenn Butner, Jr.

(Sterling College)

Speaking of a Relational God: How
Analogy and Divine Attributes Norm
Talk of the Trinity

4:40 PM—5:20 PM

Ian J Maddock

(Sydney Missionary and Bible College)

Predestination Calmly Considered?
Luther, Wesley and the Doctrine of
Election

5:30 PM—6:10 PM

Murilo R Melo

(Dallas Theological Seminary)

Imitatio Trinitatis as a Bridge
Between Ecclesiology and Progressive
Sanctification

D 3:00 PM-6:10 PM

The Creation Project

Tower Building – Majestic Level
Majestic Ballroom

Moderator: Richard E. Averbeck

(Trinity Evangelical Divinity School)

3:00 PM—3:40 PM

James K. Hoffmeier*

(Trinity Evangelical Divinity School)

"Can We Believe in Creation and
Evolution?" – A Preliminary Report
on an Ongoing Research Project

3:50 PM—4:30 PM

Dru Johnson*

(The King's College)

Does Genesis 1 – 11 Contain a
Critique of Theistic Evolution?

4:40 PM—5:20 PM

Gavin Ortlund

(First Baptist Church of Ojai)

Augustine on Adam and Eve

5:30 PM—6:10 PM

Ryan S. Peterson

(Talbot School of Theology / Biola

University)

Human Identity in Theological and
Scientific Anthropologies

7:00 PM - 8:00 PM

Banquet

Plaza Building – Concourse Level
Plaza Ballroom

8:00 PM - 9:00 PM

Presidential Address

Plaza Building – Concourse Level
Plaza Ballroom

David S. Dockery

(Trinity International University)

Toward a Theology of Evangelical
Higher Education

Thursday

8:30 AM - 9:20 AM

ETS Plenary Session III

Plaza Building – Concourse Level
Plaza Ballroom

Michael Horton

(Westminster Seminary California)

Lord and Life-Giver: The Holy
Spirit's Role in the History of
Redemption

9:30 AM - 10:00 AM

Corporate Worship

Plaza Building – Concourse Level
Plaza Ballroom

10:15 AM - 11:15 AM

ETS Business Meeting

Plaza Building – Concourse Level
Plaza Ballroom

10:15 AM - 11:15 AM

EPS Business Meeting

Tower Building – 2nd Floor
Tower Court D

11:15 AM - 12:45 PM

Lunch Break

Thursday, November 15 1:00 PM – 4:10 PM

P 1:00 PM-4:10 PM

Analytic Theology

Salvation by Allegiance Alone?

Tower Building – Terrace Level
Terrace

Moderator: Thomas McCall
(Trinity Evangelical Divinity School /
University of St Andrews)

Respondents:

Amy Beverage Peeler
(Wheaton College)

Liz Jackson*
(University of Notre Dame)

Joshua Jipp
(Trinity Evangelical Divinity School)

Matthew Bates*
(Quincy University)

2:05 PM—2:35 PM
David Luy
(Trinity International University)
Lutheran View

2:35 PM—3:05 PM
Michael Allen
(Reformed Theological Seminary)
Reformed View

3:05 PM—3:35 PM
David Buschart
(Denver Seminary)
Non-Denominational View

3:35 PM—3:55 PM
Panel Discussion

3:55 PM—4:10 PM
Audience Q&A

2:20 PM—2:50 PM
Matthew Arbo
(Oklahoma Baptist University)
Early Modern Political Theologies
and the Liberal Tradition

3:00 PM—3:30 PM
Vince Bacote
(Wheaton College)
Seeking a Better Freedom

3:40 PM—4:10 PM
Panel Discussion

P 1:00 PM-4:10 PM

Greco-Roman Backgrounds *Adoption in the Greco-Roman* *World*

Tower Building – Terrace Level
Capitol

Moderators:
Bernie Cueto
(Palm Beach Atlantic)
Randy Richards
(Palm Beach Atlantic)
Lynn Cohick
(Denver Seminary)
Joey Dodson
(Ouachita Baptist University)

1:00 PM—1:40 PM
David Capes*
(Wheaton College)
Adoption in the Jesus Tradition

1:50 PM—2:30 PM
Erin Heim
(Denver Seminary)
Reading Adoption with the
Vanquished

P 1:00 PM-4:10 PM

Anglican Theology *Confessions, Creeds, and* *Reformed Catholicity*

Tower Building – Mezzanine Level
Gold

Moderator: Joel Scandrett
(Trinity School for Ministry)

1:00 PM—1:05 PM
Joel Scandrett
(Trinity School for Ministry)
Introduction

1:05 PM—1:35 PM
Greg Peters
(Biola University)
Anglican View

1:35 PM—2:05 PM
Lucas Stamps
(Anderson University)
Baptist View

P 1:00 PM-4:10 PM

Christian Ethics *Redeeming Liberalism?:* *Christianity and the Future of* *Liberal Politics*

Plaza Building – Lobby Level
Director's Row J

Moderator: Ryan Welsh
(Redeemer Church, Seattle WA)

1:00 PM—1:30 PM
Daniel Strand
(Arizona State University)
From Rights to Obligation: Shifting
the Ground of the Debate

1:40 PM—2:10 PM
Debra Erickson*
(Bloomsburg University)
Religion, Democracy, and the Paradox
of Liberal Illiberalisms

*Invited Guest of ETS

Thursday, November 15 1:00 PM – 4:10 PM

2:40 PM—3:20 PM

Joe Fantin

(Dallas Theological Seminary)

Adopted into the Family of God:
Ephesians 1:5 in light of Roman
Adoption

3:30 PM—4:10 PM

James Harrison

(Sydney College of Divinity)

Romans 1:2-4 and Imperial
'Adoption' Ideology: Election,
Sonship, and Apotheosis

P 1:00 PM-4:10 PM

Johannine Literature

Tower Building – Majestic Level

Savoy

Moderators:

Robert W. Yarbrough

(Covenant Theological Seminary)

Edward W. Klink III

(Hope Church)

1:00 PM—1:40 PM

David B. Sloan

(Trinity Evangelical Divinity School)

The Johannine Secessionists:
Docetists or Jews Maintaining
Fidelity to the Synagogue?

1:50 PM—2:30 PM

Raju D. Kunjummen

(Emmaus Bible College)

Abiding in the True Vine: Exegetical
Solutions to Some Interpretive
Difficulties in John 15:1-10

2:40 PM—3:20 PM

David Christensen

(Southern Baptist Theological Seminary)

Convergence of Exodus Imagery in
the Bookends of the Fourth Gospel

3:30 PM—4:10 PM

Randy Rheaume

(Stony Creek Church)

"Abraham Rejoiced to See My Day
and Saw It": Jesus' Take on
Theophanies

P 1:00 PM-4:10 PM

Luke / Acts

Contemporary Reflections on the
Holy Spirit in Acts

Tower Building – Terrace Level

Biltmore

Moderator: Mark L. Strauss

(Bethel Seminary San Diego)

1:00 PM—1:40 PM

Graham Twelftree*

(London School of Theology)

'Worship in the Spirit' in the Acts of
the Apostles

1:50 PM—2:30 PM

Carlos Sosa Siliezar*

(Wheaton College)

Acts, the Spirit, and Latin American
Hermeneutics

2:40 PM—3:20 PM

Robert Menzies*

(Asian Center for Pentecostal Theology)

R.A. Torrey's Enduring Theological
Legacy: The Pentecostal Movement

3:30 PM—4:10 PM

Craig S. Keener

(Asbury Theological Seminary)

The Spirit, Exorcisms, and Healings in
the Acts of the Apostles

P 1:00 PM-4:10 PM

Messianic Jewish Studies

Jewish-Christian Dialogue: from
Antiquity to Today

Plaza Building – Concourse Level
Governor's Square 9

Moderator: Hélène Dallaire

(Denver Seminary)

1:00 PM—1:40 PM

Lee M. Fields

(Mid-Atlantic Christian University)

Progress and Regress: Jewish-
Christian Dialogue in Antiquity

1:50 PM—2:30 PM

Amy Downey

(Tzedakah Ministries)

Maimonides Against the Trinity:
Implications for Contemporary
Dialogue with Jewish Religious
Thought

2:40 PM—3:20 PM

Alan Shore

(Chosen People Ministries)

Modern Jewish History and the
Making of the Messianic Identity

3:30 PM—4:10 PM

Stan Meyer

(Jews for Jesus)

Balfour at 100: How British
Millennialism Paved the Road For a
Jewish Homeland

P 1:00 PM-4:10 PM

Models of God

The God of Jonathan Edwards 4

Tower Building – 2nd Floor

Tower Court A

*Invited Guest of ETS

Thursday, November 15 1:00 PM – 4:10 PM

Moderator: Dennis W. Jowers
(Faith International University)

1:00 PM—1:40 PM

Christina Larsen
(Grand Canyon University)

The Glories of the Son in Edwards' Doctrine of God

1:50 PM—2:30 PM

Seng-Kong Tan*
(Biblical Graduate School of Theology, Singapore)

Jonathan Edwards on the Divine Relations: Trinitarian *Regiratio* as a Basis for Personal Modes of Action

2:40 PM—3:20 PM

Philip Fisk*
(Evangelische Theologische Faculteit, Leuven)

Jonathan Edwards's Innovative Notion of Freedom of Will: An Historical-Theological Approach

3:30 PM—4:10 PM

Robert Caldwell
(Southwestern Baptist Theological Seminary)
The Holy Spirit as the Bond of Union in the "Objective" Spirituality of Jonathan Edwards

P 1:00 PM-4:10 PM

New Testament Canon, Textual Criticism & Apocryphal Literature

The Holy Spirit
Tower Building – Majestic Level
Vail

Moderator: Michael J. Kruger
(Reformed Theological Seminary)

1:00 PM—1:40 PM

Carlton Wynne
(Westminster Theological Seminary)
Spirit and Word: A 'Pentecostal' Case for the Closed Canon of Scripture

1:50 PM—2:30 PM

Maurice Robinson*
(Southeastern Baptist Theological Seminary)
Absent from the Handbooks? The Role of the Holy Spirit in New Testament Textual Criticism

2:40 PM—3:20 PM

Craig Blomberg
(Denver Seminary)
The Lack of Canon Consciousness and Spirit-Inspiration in the New Testament Apocrypha

3:30 PM—4:10 PM

John Christopher Thomas*
(Pentecostal Theological Seminary/Bangor University)
Diverse Voices in One Accord: Toward a Pentecostal Theology of Canon

P 1:00 PM-4:10 PM

Old Testament Prophetic and Apocalyptic Books

Zephaniah, Haggai, Zechariah, and Malachi
Plaza Building – Concourse Level
Governor's Square 16

Moderator: Paul Wegner
(Gateway Seminary)

1:00 PM—1:40 PM

Mark Boda
(McMaster Divinity College)
Bridging the Gap: Zephaniah's Rhetorical Role for the Haggai-Malachi Corpus

1:50 PM—2:30 PM

Andrew Abernethy
(Wheaton College)
The Spirit of God in the Unspectacular in Haggai

2:40 PM—3:20 PM

Beth Stovell*
(Ambrose University)
'Not by Might, Nor by Power, But by My Spirit': Conceptualizing God's Spirit and Presence in Zechariah

3:30 PM—4:10 PM

John Oswalt
(Asbury Theological Seminary)
Another Look at the Structure of Malachi: A Discourse-Analysis Perspective

P 1:00 PM-4:10 PM

Old Testament Wisdom Literature

The Wisdom of Metaphor
Plaza Building – Concourse Level
Plaza Court 8

Moderator: Christopher Ansberry
(Oak Hill College)

1:00 PM—1:40 PM

Alex Kirk
(Durham University)
Moral Animals: How Agur Uses Metaphor to Shape Character in Proverbs 30

1:50 PM—2:30 PM

Lindsay Wilson
(Ridley College)
Taking God to Court: Was Job Wise in His Use of the Legal Metaphor?

*Invited Guest of ETS

Thursday, November 15 1:00 PM – 4:10 PM

2:40 PM—3:20 PM

Knut Heim*

(Denver Seminary)

The Metaphors 'Under the Sun' and 'Under the Heavens' in the Book of Ecclesiastes

3:30 PM—4:10 PM

Brian Gault

(Columbia Biblical Seminary)

Intoxicating Fruits and Invaluable Forms: Metaphor in Song of Songs

P 1:00 PM-4:10 PM

Pauline Studies

Tower Building – Mezzanine Level
Denver

Moderator: Linda Belleville

(Grand Rapids Theological Seminary)

1:00 PM—1:40 PM

Gregory E. Lamb

(Southeastern Baptist Theological Seminary)

Living and Dying Well in Philippians: A Comparative Analysis of Ancient Sources

1:50 PM—2:30 PM

John W. Taylor

(Gateway Seminary)

Portrait of the Invisible: The Gifts of the Spirit as Divine Self-Disclosure

2:40 PM—3:20 PM

Johnathan F. Harris

(Wheaton College)

A Promising Future: The Eschatological Third View as a Way Forward in the Πίστις Χριστοῦ Debate

3:30 PM—4:10 PM

Stanley E. Porter

(McMaster Divinity College)

Beware of Philippians 3:2: Reconsidering a Supposed Imperative

P 1:00 PM-4:10 PM

Public Theology

Holy Spirit Justice

Plaza Building

Concourse Level — Plaza Court 6

Moderator: Greg Forster

(Trinity International University)

Darrell Bock

(Dallas Theological Seminary)

Is Culture War the Best Prism for Holy Spirit Justice?

Kristen Deede Johnson*

(Western Theological Seminary)

'Endow the King with Your Justice, O God': Exploring the Role of the Holy Spirit in a Pluralistic Context

Jemar Tisby

(University of Mississippi)

Soul Liberation: Black Evangelical Engagement with Black Power

Amos Yong*

(Fuller Theological Seminary)

Which Commons, Whose Colors, What Goods? A (Perpetually) Foreign Witness in the Public Theological Wilderness

P 1:00 PM-4:10 PM

The Book of Revelation

The Holy Spirit in the Book of Revelation

Tower Building – Terrace Level

Beverly

Moderator: Alan Bandy

(Oklahoma Baptist University)

1:00 PM—1:30 PM

Mark Wilson

(Stellenbosch University)

The Spirit in Revelation: Explorations in Imagery and Metaphor

1:40 PM—2:10 PM

Robby Waddell*

(Southeastern University)

The Pentecostal Spirit, the Church, and the Book of Revelation

2:20 PM—2:50 PM

Alan Hultberg

(Talbot School of Theology)

The Seven Spirits Revisited: Assessing the Origin of the Image of the Seven Spirits in Revelation

3:00 PM—3:30 PM

David Mathewson*

(Denver Seminary)

The Holy Spirit in the New Creation (Rev 21:1-22:5)

3:40 PM—4:10 PM

Panel Discussion:

Toward a Pneumatology of John's Apocalypse

P 1:00 PM-4:10 PM

Theological Education and Pedagogy

What I've Learned as an Educator and Leader

Tower Building – 2nd Floor

Grand Ballroom II

Moderator: Paul R. House

(Beeson Divinity School)

*Invited Guest of ETS

Thursday, November 15 1:00 PM – 4:10 PM

1:00 PM—1:40 PM

R. Albert Mohler Jr.

(Southern Baptist Theological Seminary)
What I've Learned as an Educator
and Leader

1:50 PM—2:30 PM

Graham Cole

(Trinity Evangelical Divinity School)
Doing Theological Education on
Three Continents: Some Personal
Reflections

2:40 PM—3:20 PM

Timothy George

(Beeson Divinity School)
Teaching Masterfully: The Greatest
Teachers I've Known

3:30 PM—4:10 PM

Panel Discussion

P 1:00 PM-4:10 PM

Trinitarian Theology

Reflecting on the Relational
Trinity

Tower Building – Mezzanine Level
Century

Moderator: Josh Malone

(Palm Beach Atlantic University)

1:00 PM—1:40 PM

Grant Macaskill*

(University of Aberdeen)
Union with Christ and the Relational
Trinity

1:50 PM—2:30 PM

Steve Duby

(Grand Canyon University)
Monotheism, Divine Unity, and the
Relational Trinity

2:40 PM—3:20 PM

Ben Rhodes

(Joni and Friends Christian Institute on
Disability)
Filioque and the Relational Trinity

3:30 PM—4:10 PM

Scott Harrower

(Ridley College)
'Relation' in Bonaventure, Aquinas,
and Relational Trinitarianism

P 1:00 PM-4:10 PM

Warfare and Violence in the Old Testament

Conquest and Divine Violence:
Interaction with Recent Proposals
Plaza Building – Concourse Level
Plaza Court 7

Moderator: Charlie Trimm

(Biola University)

1:00 PM—1:40 PM

Ralph Hawkins

(Averett University)
The Sinfulness of the Canaanites and
Walton and Walton's *The Lost World
of the Israelite Conquest*

1:40 PM—2:20 PM

Eric Barrios

(Hebrew Union College)
Exile as *Herem* and John H. Walton
and J. Harvey Walton's *The Lost
World of the Israelite Conquest*

2:20 PM—3:00 PM

Lissa Wray Beal*

(Providence Theological Seminary)
The Nature of Divine Judgment and
Greg Boyd's *Crucifixion of the
Warrior God*

3:10 PM—3:30 PM

M. Daniel Carroll R.

(Wheaton College)
Reflections from a Christotelic
Pacifist on Greg Boyd's Christocentric
Pacifism

3:30 PM—4:10 PM

Panel Discussion

A 1:00 PM-4:10 PM

Adventist Theological Society

Plaza Building – Lobby Level
Director's Row I

Moderator: Carl P. Cosaert

(Walla Walla University)

1:00 PM—1:40 PM

Elikphin Zanthia

(Tema, Ghana)
Revisiting the Question of the Holy
Spirit as God

1:50 PM—2:30 PM

Justice Kow Mensah

(University of Oslo, Norway)
The Quranic Perception of the
Personality of the Holy Spirit

2:40 PM—3:20 PM

Elmer Guzman

(Andrews University)
The Usage of the Pneumatological
Guidance of the Church

3:30 PM—4:10 PM

Leander Chalice

(Helderberg College, South Africa)
A Defense of the Holy Spirit as God
from a Biblical/Linguistic Perspective

*Invited Guest of ETS

Thursday, November 15 1:00 PM – 4:10 PM

A 1:00 PM-4:10 PM

Evangelical Philosophical Society E1

Tower Building – 2nd Floor
Tower Court B

Moderator: Sarah C. Geis
(Denver Seminary)

1:00 PM—1:40 PM

David Haines

(Veritas International University /
Association Axiome)

Natural Theology, Perspectivalism,
and the Assumption of the Divine

1:50 PM—2:30 PM

Matthew Flanagan

(St. Peter's College)

Why the Euthyphro Objection Is Still
A Bad Argument

2:40 PM—3:20 PM

Joseph Jedwab

(Kutztown University)

Two Atonement Theories and the
Problem of Christ's Suffering and
Death

3:30 PM—4:10 PM

Joshua R. Farris

(Houston Baptist University)

S. Mark Hamilton

(VU Amsterdam)

Divine Justice and Craig's Penal
Substitution Theory of Atonement

A 1:00 PM-4:10 PM

Evangelical Philosophical Society E2

Tower Building – 2nd Floor
Tower Court C

Moderator: Gary Osmundsen
(Grand Canyon University)

1:00 PM—1:40 PM

Ronnie Campbell

(Liberty University)

Pneumatological Explorations into
the Defeat of Evil

1:50 PM—2:30 PM

Andrew I. Shephardson

(Life Pacific College and the King's
University)

A Critique of Postmodern Evangelical
Rejections of Natural Theology

2:40 PM—3:20 PM

Kyle Beshears

(University of Mobile)

Choosing Hemlock or Parsley: A

Survey of Apatheism and Theological
Acedia

3:30 PM—4:10 PM

Hayden Stephan

(Saint Louis University)

Divine Command Theory Requires
Divine Retributive Justice

A 1:00 PM-4:10 PM

Evangelical Philosophical Society E3

Tower Building – 2nd Floor
Tower Court D

Moderator: Kevin W. Wong

(Wheaton College Graduate School)

1:00 PM—1:40 PM

Dennis Bray

(University of St Andrews)

Richard of St. Victor's Argument for
the Necessity of the Trinity

1:50 PM—2:30 PM

Chris L. Firestone

(Trinity International University)

The Christ-Shaped Philosophy Project:
The Status Quastionis and a Defense
of Moser

2:40 PM—3:20 PM

Michael Willenborg

(Baylor University)

Jesus, Alienation, and Penal
Substitution

3:30 PM—4:10 PM

Mike DeVito

(Houston Baptist University)

Tyler McNabb

(Houston Baptist University)

Kegan J. Shaw

(University of Edinburgh)

Proper Functionalism and

Epistemological Disjunctivism: A
Synergistic Proposal

A 1:00 PM-4:10 PM

Near East Archaeological Society E

General Biblical Archaeology

Plaza Building – Concourse Level
Governor's Square 17

Moderator: Donald McNeeley
(Tidewater Bible College)

1:00 PM—1:40 PM

Steve Rudd

(Shiloh Archaeological Excavation Staff)

Jewish Messianic Expectation in

Coins and Dead Sea Scrolls in 30 BC

1:50 PM—2:30 PM

Doug Petrovich

(The Bible Seminary)

The Short Sojourn: A Faulty View and
a Fatal Flaw in Rohl's New
Chronology

2:40 PM—3:20 PM

Clyde Billington

(Artifax)

What Happened to the Temple
Menorah?

Thursday, November 15 1:00 PM – 4:10 PM

3:30 PM—4:10 PM

Robert Smith

(Mid-Atlantic Christian University)

Muslim and Christian Veneration at the Pilgrimage Complex of Abila in Late Antiquity

T 1:00 PM-4:10 PM

Holy Spirit - Church History

20th-21st Century

Plaza Building – Lobby Level

Director's Row E

1:00 PM—1:40 PM

Mark H Ballard

(Northeastern Baptist College)

A Consideration of D. L. Moody's Use of the Phrase, Baptism of the Holy Spirit

1:50 PM—2:30 PM

Timothy K. Beougher

(Southern Baptist Theological Seminary)

Billy Graham and the Holy Spirit

2:40 PM—3:20 PM

Matthew Winslow

(East Asia School of Theology)

The Impact of Jonathan Goforth's Pneumatology on Early Twentieth-Century Chinese Christianity

3:30 PM—4:10 PM

Oscar Merlo

(Talbot School of Theology, Biola University)

The Work of the Holy Spirit in Cuba: Inflaming Evangelism throughout the Island. Acts 1:8

T 1:00 PM-4:10 PM

Holy Spirit - Practical Theology

General Studies 2

Tower Building – Mezzanine Level

Silver

1:00 PM—1:40 PM

Glenn Packiam

(Durham University)

Spirit of Hope: God's Eschatological, Empowering, and Incarnational Presence in Worship

1:50 PM—2:30 PM

Douglas Groothuis

(Denver Seminary)

How the Holy Spirit Grounds the Knowledge of God through Liturgy

2:40 PM—3:20 PM

Richard J. McLaughlin

(Trinity International University)

A Biblical/Historical Case for Global Christian Spiritual Renewal

3:30 PM—4:10 PM

Nelson S. Hsieh

(Southern Baptist Theological Seminary)

What Is the "Gift" of Singleness?: An Argument Against the Gift as an Ability Given to Some

T 1:00 PM-4:10 PM

Holy Spirit - Systematic Theology

Anthropology and Ecclesiology

Plaza Building – Concourse Level

Governor's Square 14

Moderator: Justin McLendon

(Grand Canyon University)

1:00 PM—1:40 PM

Brian J. Wright

(Be United in Christ Outreach Ministry)

John R. Brown

(Be United in Christ Outreach Ministry)
The Holy Spirit and Christian Unity

1:50 PM—2:30 PM

Daniel L. Hill

(Wheaton College)

Breathe on Us, O Breath of God – The Spirit's Work in Shaping Personal Identity

2:40 PM—3:20 PM

Kelly M. Kapic

(Covenant College)

How the Holy Spirit Affirms and Delights in Human Finitude

3:30 PM—4:10 PM

Mark Coppenger

(Southern Baptist Theological Seminary)

Bullish Anthropology/Bearish Pneumatology (and Vice Versa)? Restorationism vs. Calvinism

T 1:00 PM-4:10 PM

Holy Spirit - Systematic Theology

General Studies 3

Plaza Building – Concourse Level

Governor's Square 11

Moderator: Michael Whitlock

(Truett McConnell University)

1:00 PM—1:40 PM

Robert J. Matz

(Midwestern Baptist Theological Seminary)

Why Spirit Baptism Demands Contemporaneous Water Baptism for Credobaptists

1:50 PM—2:30 PM

Dustin Turner

(New Orleans Baptist Theological Seminary)

Symbol and Sacrament: The Relationship between Spirit- and Water-Baptism among Baptists

Thursday, November 15 1:00 PM – 4:10 PM

2:40 PM—3:20 PM

Christopher Woznicki

(Fuller Theological Seminary)

Reversing Our Neglect of the Holy Spirit in Theological Epistemology: A Torrancean Proposal

3:30 PM—4:10 PM

David Moser

(Southern Methodist University)

The Holy Spirit, the Trinity, and the Miracle of Christ's Bodily Conception according to Aquinas

T 1:00 PM-4:10 PM

Holy Spirit - Systematic Theology

Soteriology

Plaza Building – Concourse Level
Governor's Square 12

Moderator: Austin M. Freeman
(Trinity Evangelical Divinity School)

1:00 PM—1:40 PM

Adam J Johnson

(Biola University)

The Spirit of the Cross: The Role of the Holy Spirit in the Doctrine of the Atonement

1:50 PM—2:30 PM

David L. Allen

(Southwestern Baptist Theological Seminary)

The Role of the Holy Spirit in the Atonement and Its Application

2:40 PM—3:20 PM

Dolf te Velde

(Theological University Kampen / ETF Leuven)

Effective and Divine: The Role of the Holy Spirit in the Canons of Dordt (1619)

3:30 PM—4:10 PM

Kendall Cleveland

(University of St Andrews)

The Spirit and the Pactum: Analyzing John Owen's Doctrine of the Covenant of Redemption

D 1:00 PM-4:10 PM

Church History

Baptist and Puritan Theology

Tower Building – Mezzanine Level
Colorado

Moderator: Jeff Cockrell

(Welch College)

1:00 PM—1:40 PM

Jesse F. Owens

(Welch College)

Matthew Caffyn, Thomas Monck, and English General Baptist Creedalism

1:50 PM—2:30 PM

Jonathan E. Swan

(Southern Baptist Theological Seminary)

John Gill's (1697 – 1771) Reformed Doctrine of Eternal Generation and the Aseity of the Son

2:40 PM—3:20 PM

Seth Osborne

(Southern Baptist Theological Seminary)

The Reformed and Celibate Pastor: Richard Baxter's Pastoral Model and the Appeal of Clerical Celibacy

3:30 PM—4:10 PM

Kevin Hall

(Southern Baptist Theological Seminary)

Jonathan Edwards and the Sanctification Debate: Three Key Undercurrents in the Christian Life

D 1:00 PM-4:10 PM

Church History

Edwards

Tower Building – 2nd Floor
Windows

Moderator: Joseph W. Lee

(Dallas Theological Seminary)

1:00 PM—1:40 PM

William D. Henard III

(Southern Baptist Theological Seminary)
Jonathan Edwards' Spiritual Sense of Scripture: The Holy Spirit's Role in Hermeneutics

1:50 PM—2:30 PM

Glenn R. Kreider

(Dallas Theological Seminary)

Danielle W. Ross

(Dallas Theological Seminary)

"Visibly Wicked Persons Ought Not to Be Tolerated in the Church":
Edwards and Excommunication

2:40 PM—3:20 PM

Zach Bowden

(Cedarville University)

What's Love Got To Do With It?
Jonathan Edwards, the New Divinity,
and the Nature of True Virtue

3:30 PM—4:10 PM

Matthew Raley

(Living Hope Fellowship, Chico, CA)

A Rational and Spiritual Worship:
Comparing J. S. Bach and Jonathan
Edwards

D 1:00 PM-4:10 PM

Karl Barth, the Holy Spirit, and Pentecostal Systematic Theology

Tower Building – Mezzanine Level
Spruce

Thursday, November 15 1:00 PM – 4:10 PM

Moderator: Andrew K. Gabriel
(Horizon College and Seminary)

1:05 PM—1:35 PM

Gary Tyra
(Vanguard University)

Revelation as Encounter: Karl Barth,
Pneumatological Realism, and
Prophetic Preaching

1:35 PM—2:05 PM

Steven M. Studebaker
(McMaster Divinity College)

A Barthian and Pentecostal turn to
the Holy Spirit in the Doctrine of the
Trinity

2:05 PM—2:35 PM

Andrew K. Gabriel
(Horizon College and Seminary)

The Spirit and the Divine Attributes:
Pentecostals and Barth on
(Im)mutability & (Im)passibility

2:35 PM—3:05 PM

Lisa P. Stephenson
(Lee University)

Christ, the Spirit, and Humanity:
Barth's I-Thou in Pneumatological
Perspective

3:05 PM—3:25 PM

Respondent: Sung Wook Chung
(Denver Seminary)

3:25 PM—4:10 PM

Panel Discussion and Q&A

D 1:00 PM-4:10 PM

New Testament

General Studies

Tower Building – Terrace Level

Columbine

Moderator: Victor Copan
(Palm Beach Atlantic University)

1:00 PM—1:40 PM

Alexander E. Stewart

(Tyndale Theological Seminary)

Show Me the Money: Pedagogy,
Numismatics, and the New Testament

1:50 PM—2:30 PM

J. D. Atkins

(Trinity Evangelical Divinity School)

Fitting Gnosis into the Biblical
Timeline of Acts: *The Apocryphon of
James*

2:40 PM—3:20 PM

S. Michael Ahn

(Gateway Seminary)

Messianic Prefigures of Early Judaism
and New Testament Christology

3:30 PM—4:10 PM

Philip Barton Payne

(Linguist's Software, Inc.)

The Significance of the Seventeen
Vaticanus Distigma-obelos symbols
for NT Textual Criticism

D 1:00 PM-4:10 PM

New Testament

Pauline Literature 3

Plaza Building – Lobby Level

Director's Row H

Moderator: James Bibza

(Grove City College)

1:00 PM—1:40 PM

Matthew Monkemeier

(Wheaton College)

"In You Our Ancestors Put Their
Trust": Psalm 22 and the "Faith of
Christ" in Romans 1 – 4

1:50 PM—2:30 PM

L. Timothy Swinson

(Liberty University)

Doing and Upholding the Law in
Romans 2-3

2:40 PM—3:20 PM

Trevor Clark

(Gateway Seminary)

Romans and the Hermeneutics of
Hope

3:30 PM—4:10 PM

Brian Neil Peterson

(Lee University)

A Possible Scriptural Precedent for
Paul's Teaching on Divorce (and
Remarriage?) in 1 Cor 7

D 1:00 PM-4:10 PM

Old Testament

OT Theology and Hermeneutics

Plaza Building – Concourse Level

Governor's Square 15

Moderator:

W. Creighton Marlowe

(Evangelische Theologische Fakultät)

1:00 PM—1:40 PM

Allan Moseley

(Southeastern Baptist Theological
Seminary)

Responding to Recent Calls for the
Sacramental/Allegorical
Interpretation of the Old Testament

1:50 PM—2:30 PM

N. Blake Hearson

(Midwestern Seminary)

Sandals and the Theology of Sacred
Space in the Old Testament

2:40 PM—3:20 PM

Jens Bruun Kofoed

(Fjellhaug International University
College Denmark)

Encoding and Decoding Culture

Thursday, November 15 1:00 PM – 4:10 PM

3:30 PM—4:10 PM

Jeong Koo Jeon

(Faith Theological Seminary)
The Noahic Covenants and
Redemptive Judgment

D 1:00 PM-4:10 PM

Old Testament

Pentateuch 2

Plaza Building – Concourse Level
Governor's Square 10

Moderator: Jo Ann Davidson

(Andrews University Theological
Seminary)

1:00 PM—1:40 PM

Gregory R. Lanier

(Reformed Theological Seminary,
Orlando)

'You Shall Observe His Heel': Tracing
the Greek Tradition-History of
Genesis 3:15b

1:50 PM—2:30 PM

Pierre Gilbert

(Canadian Mennonite University)

"You shall surely die." Reading
Genesis 2:17 as a Curse and Blessing
Formula.

2:40 PM—3:20 PM

David Larson

(University of Memphis)

Burning of Incense in Egyptian
Temple Rituals: Background to the
Sin of Nadab and Abihu?

D 1:00 PM-4:10 PM

Systematic Theology

General Studies 2

Tower Building – 2nd Floor
Grand Ballroom I

Moderator: D. K. Matthews

(Asbury Theological Seminary)

1:00 PM—1:40 PM

Millard J. Erickson

(Unaffiliated scholar)
Doing Evangelical Theology in
Tomorrow's World

1:50 PM—2:30 PM

Steven Tsoukalas

(Emmaus Biblical Seminary, Haiti)

Do Christians and Muslims Worship
the Same God? The Homousios as
Foundational to the Answer

2:40 PM—3:20 PM

T. J. Gentry

(Fellowship in Christ Christian Church)

We Shall Be Like Him: Time,
Transformation, and a Theology of
the Intermediate State

3:30 PM—4:10 PM

Myk Habets

(Carey Graduate School)

Evangelical Theosis: The Apotheosis
of an Idea

D 1:00 PM-4:10 PM

Systematic Theology

Social Justice and Reconciliation

Tower Building – Majestic Level

Majestic Ballroom

Moderator: I. Leon Harris

(Talbot School of Theology/Biola
University)

1:00 PM—1:40 PM

R. Scott Smith

(Biola University)

Making Connections: Diversity-Social
Justice-White Privilege,
Postmodernism, and Nominalism

1:50 PM—2:30 PM

Page Matthew Brooks

(New Orleans Baptist Theological
Seminary / The Restoration Institute)
Re-hashing Hashtags: Developing a
Stronger Evangelical Approach to
Social Justice

2:40 PM—3:20 PM

Jesse L Parker

(Southeastern Baptist Theological
Seminary)

Black and White: the Significance of
Racial Identity in Reconciliation

3:30 PM—4:10 PM

David S. Kotter

(Colorado Christian University)

The Intrinsic and Instrumental Value
of Work: A Biblical Response to the
Basic Income Guarantee

Participant Index

Abernethy, Andrew	25, 55	Barwegen, Laura	33, 47	Breshears, Gerry	13, 23
Adair, John	23, 43	Bateman IV, Herbert W.	34	Briones, David E.	50
Ahn, S. Michael	61	Bates, M. Todd	43	Brooks, Page Matthew	62
Akers, Matthew R.	51	Bates, Matthew	53	Brown, John R.	59
Alexander, David E.	15, 26	Battaglia, Peter	49	Brown, Patrick	38
Allen, David L.	60	Bauder, Kevin T.	50	Brown, Philip	38
Allen, Jason K.	21	Baugh, S. M.	16	Browning, Benjamin	28
Allen, Michael	38, 50, 53	Beale, G. K.	33	Bruce, Dustin	33
Allison, Gregg	18, 31, 44	Beall, Todd	23	Bruno, Chris	30, 37
Anderson, Owen	49	Beck, Peter	19	Brunton, Jacob	27
Andrews, Stephen J.	14	Beckman, John C.	35	Bryant, Jared	45
Aniol, Scott	33, 43	Beckwith, Francis J.	38	Bryson, Anthony	15, 38
Ansberry, Christopher	55	Beeke, Joel	37	Bryson, Jennifer	44
Arbo, Matthew	53	Belleville, Linda	46, 56	Buller, Daniel	46
Arcadi, James M.	41	Bello, Rafael	21	Bullock, C. Hassell	20
Arnold, Brian J.	25	Benbrooks, Jeremy R.	40	Burer, Michael H.	14, 26
Arnold, Jonathan	28	Beougher, Timothy K.	59	Burk, Denny	32
Atherstone, Andrew	43	Berger, H. Stephen	26	Burton, Kelly Fitzsimmons	49
Atkins, J. D.	61	Beshears, Kyle	58	Buschart, David	53
Austin, Michael W.	15	Bibza, James	61	Buth, Randall	42
Auxier, John W.	23	Billington, Clyde	58	Butler, Rex	28
Averbeck, Richard E.	36, 52	Bingham, D. Jeffrey	18, 46	Butner, Jr., D. Glenn	52
Bacote, Vince	53	Bird, Michael	22	Caldwell, Robert	32, 55
Baggett, Dave	39	Blakemore, Steve	38	Calvert, David J.	33
Bagwell, Kyle W.	18, 24	Blois, Isaac	19	Campbell, Ronnie	58
Bailey, Garrick M.	16	Blomberg, Craig	55	Campos, Jr., Heber	34
Bailey, Richard A.	48	Bock, Darrell	44, 56	Caneday, Ardel B.	35, 51
Baise, Bryan	22	Boda, Mark	55	Capes, David	53
Baker, Mark	20	Bonevac, Dan	49	Carroll R, M. Daniel	25, 57
Ballard, Mark H.	59	Booth, Robert	31	Carter, Craig	22
Ballitch, Andrew	24	Borland, Jonathan C.	45	Cartwright, John	21
Ballivian, Joel	49	Borvan, Daniel	37	Casas, David	39
Bandy, Alan	56	Bowden, Zach	60	Castelo, Daniel	35
Bankston, Will	18	Bowman Jr., Robert M.	29	Cefalu, Rita F.	21
Barker, Kit	51	Boyer, Steven D.	31	Cen, Esther G.	19
Barrett, Matthew	40, 50	Bracey, Matthew Steven	18	Chacko, Abraham	17
Barrios, Eric	57	Brandt, Ryan A.	31	Chalice, Leander	57
Barry, David P.	28	Bray, Dennis	58	Chandler, William T.	16

Participant Index

Chang, Geoffrey	50	Curtis, Byron G.	36	Elliott, James	15
Chapman, David	36	Daeley, Justin J.	27	Elliott, Maurice	41
Chatraw, Joshua	18	Davidson, Jo Ann	20, 62	Eng, Daniel K.	26
Chen, Guang	23	Davidson, Richard M.	39	Erdel, Timothy Paul	13
Chen, Kevin	20	Davis, Ellen F.	48	Erickson, Debra	53
Chisholm, Jr., Robert B.	45	Davis, John Jefferson	40	Erickson, Millard J.	62
Cho, Dongsun	29	Davis, Richard	38	Estes, Daniel	46
Chou, Abner	17	Dawson, Zachary K.	14	Estes, Douglas	14, 28
Christensen, David	54	Dealy, Connor	27	Estrada III, Rodolfo Galvan	16
Christian, Timothy J.	17	DelHousaye, John	41	Estrada, Sergio A.	24
Chun, Chris	19, 33	Dempster, Stephen	25, 51	Etzel, Gabriel	21
Chung, Sung Wook	35, 61	Denhollander, Jacob	23	Everist, Randy	15, 38
Clark, Trevor	61	Denhollander, Rachael	23	Fanning, Buist M.	34
Clendenen, E. Ray	31	Dennis, Victoria	16	Fantin, Joe	54
Cleveland, Christopher	49	Derickson, Gary W.	29	Farnham, Mark J.	43
Cleveland, Kendall	60	DeRouchie, Jason S.	51	Faro, Igrid	23
Co, Adamson	40	Deuel, Dave	36	Farris, Joshua R.	58
Cockrell, Jeff	36, 50, 60	DeVine, Mark	33	Faust, Avraham	39
Coe, John	37, 47	DeVito, Mike	58	Fea, John	13
Cohick, Lynn	53	DeVore, Megan	46	Fesko, John	44
Cole, Graham	57	Dickinson, Travis	15	Fields, C. Ryan	18
Coleman, Dustin Jeremy	20	Dickson, Jeffrey R.	30	Fields, Lee M.	35, 42, 54
Collins, Steve	27	Diffey, Daniel S.	17	Finley, Thomas	31
Compton, R. Bruce	22	Dixhoorn, Chad Van	37, 47	Firestone, Chris L.	58
Conway, Mary L.	13	Dodson, Joey	53	Fisk, Philip	55
Cooper, Marjorie J.	50	Downey, Amy	54	Flannagan, Matthew	58
Copan, Paul	27	Draycott, Andy	13	Folsom, Marty	29
Copan, Victor	61	Dryden, Jeff	37	Foreman, Benjamin A.	46
Coppenger, Mark	59	Duby, Steve	31, 57	Forster, Greg	56
Cornett, Wayne E.	22	Duesing, Jason G.	30	Franks, W. Paul	15, 27
Cosaert, Carl P.	57	Duncan, J. Ligon	21, 40	Freeman, Austin M.	30, 60
Cowan, Steven B.	49	Dunham, Kyle C.	23, 36	Fresch, Christopher J.	47
Cox, Michael	43	Dunne, John Anthony	28	Friedeman, Caleb T.	26
Cress, Graydon	45	Duvall, J. Scott	44	Friedeman, Matt	38
Cruise, Charles E.	19	Dyer, Bryan	44	Fugitt, Mark	19
Cueto, Bernie	53	Eccher, Stephen Brett	47	Fuhr Jr., Richard Alan	31
Culy, Martin M.	24, 35	Edmondson, Todd	48	Fuller, Russell T.	35
Cumming, Joseph	44	Ehlke, Roland C.	39	Futato, Mark	35

Participant Index

Gabriel, Andrew K.	61	Gundersen, Gunner	20	Henning, Bruce	26
Gabrielson, Timothy A.	24, 42	Gurry, Peter J.	45	Hernandez, Tamra J.	44
Gagnon, Robert	37	Guzman, Elmer	57	Hess, Elijah	27
Gallagher, Edmon L.	47	Habermas, Gary	48	Hester, David W.	40
Gallos, Erhard	48	Habets, Myk	62	Hexham, Irving	30
Ganssle, Gregory E.	48	Haddad, Mimi	23	Hiestand, Gerald	18
Gault, Brian	56	Haines, David	58	Higginbotham, Lance	17
Gazal, Andre	19, 28	Hall, David W.	29, 37, 47	Hilbelink, B.J.	24
Geis, Sarah C.	38, 58	Hall, Kevin	60	Hilber, John	23
Geivett, Doug	39	Hamilton Jr., James M.	13, 35, 42	Hill, Daniel L.	59
Gentry, Peter J.	37, 51	Hamilton, S. Mark	58	Hixson, Elijah	30, 45
Gentry, T. J.	62	Hammett, John	34	Hoffman, Paul A.	17
George, Timothy	57	Hanson, Brian L.	16	Hoffmeier, James K.	36, 52
Gifford, Jr., James D.	30	Harbin, Michael A.	20	Hollingsworth, Andrew	24
Gilbert, Pierre	62	Harding, Matthew Scott	37	Holm, Doug	16
Gilhooly, John R.	22	Hardy II, H. H.	35	Horrell, J. Scott	52
Gill, Malcolm	51	Hardy, Chad	24	Horton, Michael	50, 52
Gingrich, Fred	14	Harper, G. Geoffrey	20	Hoselton, Luke Richard	17
Glenny, W. Edward	24, 43	Harris, Dana M.	14, 25, 44	Hough, Casey B.	17
Godfrey, W. Robert	37	Harris, I. Leon	62	House, Paul R.	48, 56
Goeman, Pete	20	Harris, Johnathan F.	56	Howard, Evan B.	47
Goodrich, John	50	Harrison, James	54	Howard, Jr., David M.	46 – 47
Gorra, Joe	38	Harrod, Joseph	19	Howe, Timothy	41
Graham Jr., Michael T.	46	Harrower, Scott	25, 57	Howell, Adam J.	19
Graham, Christopher A.	18, 52	Harwood, Adam	29	Hsiao, Tim	15
Graham, Keith	49	Hassler, Mark A.	16, 31	Hsieh, Nelson S.	59
Grant, Jamie	46 – 47	Hawkins, Ralph	15, 57	Hughes, John	41
Gray, John	28	Haydon, Ron	45	Hultberg, Alan	56
Green, Bradley G.	19	Haykin, Michael A.	32, 44	Hwang, Jerry	37
Greenberg, Jim	36	Hays, J. Daniel	46	Hyde, Keith	34
Greever, Joshua M.	17	Hearson, N. Blake	61	Ibrahim, Ayman	44
Greggo, Stephen P.	14, 26	Heavin, Joshua	46	Igwe, Agam Iheanyi	17
Griffith, C. Ryan	42	Hecht, Susan	24	Jackson, Christopher D.	21
Grisanti, Michael A.	25, 45	Hefner, Craig A.	24	Jackson, Liz	53
Groothuis, Douglas	15, 59	Heim, Erin	53	Jamieson, Bobby	44
Grudem, Wayne	18, 41	Heim, Knut	56	Jaros, Kurt	25
Gruendyke, Randall J.	16	Helseth, Paul Kjoss	32	Jedwab, Joseph	58
Gumerlock, Francis X.	19	Henard III, William D.	60	Jenkins, Amanda K.	31

Participant Index

Jeon, Jeong Koo	62	Knowles, Michael P.	29	Lovell, Nathan	25
Jeon, Paul S.	51	Kofoed, Jens Bruun	61	Luy, David	53
Jipp, Joshua	53	Kotter, David S.	62	Lyon, Jeremy	23
Johnson, Dru	52	Kramer, Lance M.	26	Macaskill, Grant	57
Johnson, Elliott	34	Kreider, Glenn R.	32, 43, 60	MacGregor, Kirk R.	15, 29, 40
Johnson, Eric L.	15, 51	Kroll, Kimberley	29	Maddock, Ian J.	52
Johnson, Kristen Deede	56	Kruger, Michael J.	55	Madsen, Thorvald	28
Johnston, Thomas P.	28	Kuiken, Jerome Van	38	Magnuson, Ken	23
Jones, Clay	15	Kunjummen, Raju D.	54	Malick, David E.	13
Jones, Jennifer Brown	31, 47	Kurtz, Ronni	21, 50	Malone, Josh	57
Jones, Jordan W.	14	Laansma, Jon	44	Mangum, R. Todd	43
Jones, Timothy Paul	21	Laing, John D.	23	Manor, Dale	39
Jones, Zachary	33	Laing, Stefana Dan	45	Marineau, Robert	36
Joslin, Barry	28	Lamb, Gregory E.	56	Marko, Jonathan S.	40
Jowers, Dennis W.	55	Land, Christopher D.	35	Marlowe, W. Creighton	17, 61
Jumper, Mark A.	20	Lane, Nathan C.	39	Marsh, William M.	16
Kaiser, Walter	34	Langley, Stuart	46	Martin, Iver	47
Kapic, Kelly M.	59	Lanier, Gregory R.	47, 62	Martin, Oren	31
Keathley, Ken	24	Larmer, Robert	39	Mathewson, David	56
Keener, Craig S.	42, 44, 54	Larsen, Christina	55	Matlock, Jr., Glenn R.	20
Kees, Jason P.	31	Larsen, David	21	Matthews, D. K.	62
Kelly, Jon	27, 49	Larsen, Timothy	43	Matz, Brian	45 – 46
Kelly, Stewart	30	Larson, David	62	Matz, Robert J.	59
Kieser, Ty	28	Laurence, Trevor	13	Maurer, Joshua	28
Kilner, John	33	Leavenworth, James	30	McAffee, Matthew	14
Kim, Hee Suk	20	Lee, Chee Chiew	44	McAllister, Derek	33
Kim, Ji Hoe	14	Lee, Chris D.	15, 27	McCall, Thomas	38, 53
Kim, Joseph A.	18	Lee, John	14	McClymond, Michael J.	34
King, Jonathan	22	Lee, Joseph W.	60	McCoy, Katie	22
King, Kevin	28	Leidenhag, Joanna M.	29	McCray, Alden C.	30
Kira, Joshua	22	LeMahieu, Nathan	26	McDermott, Gerald	40
Kirk, Alex	55	Licon, Michael	14	McElmurray, Chris	30
Klauber, Martin	37	Liederbach, Mark D.	17	McKelvey, Michael	26, 47
Kleiser, Timothy J.	41	Link, Jr., Peter	45	McKinion, Randall L.	50
Klerk, Jenny Lyn	40	Lo, Tien Chun	38	McKinley, John	49
Klink III, Edward W.	13, 54	Loftin, R. Keith	38	McLaughlin, Richard J.	59
Knight, Michelle	25	Longman, Tremper	37, 46 – 47	McLendon, Justin	16, 59
Knighten, Simon	19, 41	Loose, Jonathan	39	McMullen, Michael D.	16

Participant Index

McNabb, Tyler	58	Neste, Ray Van	36	Peterson, Ryan S.	52
McNeeley, Donald	15, 27, 39, 49, 58	Ng, Esther	46	Petrovich, Doug	58
McNutt, Jennifer	43	Ng, Grace Sangalang	33	Pettegrew, Larry D.	17
McQuinn, Scott	42	Nguyen, Vinh T.	41	Phillips, Benjamin	28
Meade, John D.	51	Nichols, Stephen J.	32	Philpot, Joshua M.	39
Meek, Micah S.	17	Nichols, Terrence	49	Pierard, Richard V.	50
Meeker, Kyle	23	Noelliste, Dieumeme	43	Pinson, Matthew	33
Mellon, Brad	43	Noonan, Benjamin J.	37, 46	Plato, Michael J.	32
Melo, Murilo R.	52	Noonan, Jennifer	42	Plummer, Keith	26
Melton, Jr., Frankie J.	40	Nordby, Stephanie Nicole	38	Porter, Stanley E.	14, 24, 45, 56
Mensah, Justice Kow	57	Norman, David	19	Porter, Steven L.	14
Menuge, Angus J.L.	15, 39	Olson, Craig	27	Postell, Seth	51
Menzies, Robert	54	Ortlund, Gavin	52	Poythress, Vern S.	17
Merlo, Oscar	59	Osborne, Seth	60	Pratt, Jacob M.	31
Merrill, David	31	Osmundsen, Gary	49, 58	Price, Craig	19
Meyer, Stan	54	Oswalt, John	55	Price, Randall	49
Mickahail, Adeeb	27	Owens, Jesse F.	60	Purswell, Jeff	41
Miller, Matthew R.	20	Packiam, Glenn	59	Quarles, Charles L.	31
Miller, Timothy E.	24	Padgett, Timothy D.	22	Raley, Matthew	60
Mohler Jr., R. Albert	40, 44, 57	Palmer, Keith	14	Ralston, Timothy	42
Monkemeier, Matthew	61	Pang, Francis G.	35	Rathel, David Mark	19, 40
Monson, John	25	Park, Jong Bok	33	Redmond, Eric C.	34
Montgomery, Daniel	48	Park, Sungmin Joe	16	Reed, David Alan	16
Montgomery, John Warwick	39	Park, Sydney	44	Reeve, John W.	48
Moo, Douglas	36	Parker, Brent E.	21, 51	Renshaw, Brian	31
Mooney, D. Jeffrey	45	Parker, Jesse L.	62	Rheaume, Randy	54
Moore, Jared H.	21	Parker, Shane W.	41	Rhodes, Ben	57
Moore, Kevin L.	41	Parler, Branson	22	Ribbens, Ben	44
Moreland, J.P.	48	Patterson, Todd L.	25	Richards, Randy	53
Moseley, Allan	20, 61	Payne, Don J.	49	Richardson, Kurt Anders	35
Moser, David	60	Payne, Philip Barton	61	Richie, Cristina	28, 43
Moss, Trey	30	Peckham, John C.	35	Rickabaugh, Brandon	15, 26
Mosteller, Timothy	49	Peeler, Amy Beverage	53	Riley, Jeffrey	18
Mounce, Bill	35	Pendergraft, Robert	42	Robinson, Garet D.	21
Mullin II, Miles S.	13	Percer, Leo	30	Robinson, Maurice	55
Mwashinga, Christopher R.	48	Perkins, Harrison	47	Rockwell, Stephen	30
Myhre, Paul	42	Peters, Greg	34, 53	Rodriguez, Daniel	22
Naselli, Andy	13	Peterson, Brian Neil	45, 61	Rodriquez, Seth	27

Participant Index

Rogland, Max	13	Silzer, Sheryl Takagi	33	Strand, Daniel	53
Ross, Danielle W.	60	Simons, John S.	32	Strauss, Mark L.	41, 54
Ross, Jillian L.	51	Skowronski, David	48	Streckert, Katherine A.	16
Ross, William A.	47	Sloan, David B.	54	Stripling, Scott	39
Rothenberg, Ronald M.	41	Smedley, C. Donald	44	Strobel, Kyle	47
Rowley, Matthew	16	Smith II, Carl B.	28	Studebaker, Steven M.	61
Rucker, Timothy M.	39	Smith, Benjamin M.	20	Sullivan, Steve	46
Rudd, Steve	58	Smith, Cooper	19	Svigel, Michael J.	28
Salazar, Greg	47	Smith, Henry B.	27	Swan, Jonathan E.	60
Sanchez, Paul	50	Smith, R. Scott	62	Swanson, Scott A.	17
Sanders, Craig	22	Smith, Robert	59	Sweeney, James P.	17
Sanders, Fred	32, 50	Smith, Robert S.	41	Swinson, L. Timothy	36, 61
Savelle, Charles	19	Smith, Stephen J.	26	Tabb, Brian	30
Scandrett, Joel	53	Sneller, Christopher D.	33	Tafferner, Mario	46
Scheumann, Jesse	42	Snoberger, Mark A.	22	Takeuchi, Kumiko	29
Schnabel, Eckhard	22	Song, Kris	16	Tan, Seng Kong	55
Schnittjer, Gary	37, 45	Song, Kyunga	51	Tarr, Nathan	16
Schreiner, Patrick	20, 36	Spellman, Ched	41	Taylor, Derek W.	18
Schreiner, Thomas R.	20 – 21, 36	Spiegel, James S.	15	Taylor, John W.	56
Schrock, David S.	13	Sprinkle, Preston	32	Taylor, Justin	13
Schultz, Brian	42	Spurgeon, Andrew B.	18	Taylor, W. David	33
Schultz, Richard	36	Stamps, Lucas	53	TenElshof, Judy	38
Schwanda, Tom	47	Stanislaw, Dwight R.	27	Thellman, Gregory S.	26
Seal, Darlene M.	41	Steinmetz, Michael	29	Thielman, Frank	25
Sears, P. Chase	51	Stephan, Hayden	58	Thigpen, J. Michael	36, 44
Seevers, Boyd	16	Stephens, Mark	23	Thoennes, Erik	40
Seifrid, Mark	37	Stephenson, Lisa P.	61	Thomas, Heath A.	25, 45
Setran, David	50	Stetina, Karin	34	Thomas, John Christopher	55
Shackelford, David	24	Stevens, Chris S.	35	Thompson, Alan J.	16, 41
Shatzer, Jacob	22, 42, 48	Stevenson, Mark R.	34	Thornhill, A. Chadwick	18
Shaw, Kegan J.	27, 58	Steward, Gary	13	Timmer, Daniel C.	20
Shelton, W. Brian	25, 45	Stewart, Alexander E.	61	Tinkham Jr., Matthew L.	29, 48
Shepardson, Andrew I.	29, 58	Stewart, Ken	43	Toledo, David M.	21
Shepherd V, Albert L.	21	Stewart, Philip	51	Tracy, Steven	23
Sherman, Steve	24, 43	Stivason, Jeffrey A.	30	Trammel, Madison	19
Shin, Ben	33	Storms, Sam	21	Trimm, Charlie	57
Siliezar, Carlos Sosa	54	Stovell, Beth	55	Tsoukalas, Steven	21, 62
Silva, Kenny	29	Strachan, Owen	40	Tung, Brian H.	50

Participant Index

Turner, Dustin	59	Whitlock, Michael	59	Yoon, David I.	35
Turner, Eric	31	Whitney, Donald S.	38	Zahraee, Justin	23
Turner, J.T.	27	Wilder, Michael S.	41	Zanthia, Elikphin	57
Twelftree, Graham	54	Wilder, Terry	36		
Tyra, Gary	61	Wilhoit, James	51		
Umstattd, Rustin J.	29	Wilkinson, Michael A.	21		
Vaillancourt, Ian J.	26	Willenborg, Michael	58		
Vale, Felipe do	41	Williams, Joshua E.	51		
VanderPol, Gary	34	Williams, Kenton F.	14		
VanGemeren, Willem	25	Willitts, Joel	32		
Velde, Dolf te	60	Wills, Gregory A.	30		
Vickery, Zachary A.	47	Wilsey, John D.	30		
Vila, David H.	49	Wilson, Alistair I.	17		
Voss, Hank	18	Wilson, Andrew	20 – 21		
Wachter, Daniel von	27, 48	Wilson, Lindsay	55		
Waddell, Robby	56	Wilson, Mark	14, 49, 56		
Waggoner, Earl	33, 43	Wilson, Todd	32, 41		
Wagner, Bob	49	Wineland, John	15		
Wahlen, Clinton	48	Winslow, Matthew	59		
Walker, Andrew	32	Witmer, Stephen	34		
Wallace, Daniel B.	24	Witt, Andrew C.	26		
Wan, Jessica	21	Wittman, Tyler	32		
Ware, Bruce A.	34	Wivell, John	21		
Warren, David H.	29	Wong, Gregory T.	45		
Warren, E. Janet	26	Wong, Kevin W.	41, 49, 58		
Waters, Brent	34	Woo, Joey S.	25		
Watson, R. Gregg	45	Worley, Taylor	18		
Watson, William C.	26	Woznicki, Christopher	48, 60		
Weaver, Steve	19	Wray Beal, Lissa	57		
Wegner, Paul	36, 44, 55	Wright, Brian J.	59		
Welbaum, Sam	40	Wynne, Carlton	55		
Wellum, Stephen	50	Xu, Zhiqiu	18		
Welsh, Ryan	53	Yancey, Philip	43		
Westblade, Don	32	Yang, Eric	27		
Westfall, Cynthia Long	13, 23	Yang, Hongyi June	24		
Wheeler, Nathan G.	18	Yarbrough, Robert W. 13, 22, 36, 44, 54			
White, Charles	38	Yates, Gary E.	20		
Whitfield, Amy	48	Yong, Amos	35, 56		

Session Index

Adventist Theological Society	48, 57	Corporate Worship	52
American Christianity		Plenary Sessions	32, 42, 52
Review of <i>Believe Me</i> by John Fea	13	Presidential Address	52
Snapshots from the Reformed Tradition	32	Evangelicals and Gender	
Analytic Theology	53	Gender in Biblical Perspective	13
Anglican Theology	53	Sexual Abuse, Gender and Power	23
Applied Linguistics and Biblical Languages	42	Exploring 18th Century Evangelicalism	19
Asian/Asian-American Theology	33	Expository Preaching and Hermeneutics	34
Baptist Studies	33	General Epistles	34
Biblical Theology	13, 22	Greco-Roman Backgrounds	53
Biblical Worship	33, 42	Hebrew Language	35
Bioethics		Hermeneutics	
Open Session	43	Open Session	24
Theological Anthropology in Bioethics	33	The Role of the Holy Spirit in Christian Interpretation of Scripture	43
Christian Ethics		Holy Spirit - Church History	
Open Session	22	17th-18th Century England	28
Redeeming Liberalism?	53	18th-19th Century	16
Christian History and Thought since 1700	34, 43	20th-21st Century	59
Christianity and Culture		General Studies	16
A Conversation with Philip Yancey	43	Patristic and Medieval Era	28
Cultural Conflicts	23	Holy Spirit - New Testament	
Church History		General Studies	16
17th-18th Century	40	Pauline Literature	16 – 17, 28
19th-20th Century	50	Holy Spirit - Old Testament	
Baptist and Puritan Theology	60	General Studies	17, 39
Church Fathers	18	Holy Spirit - Practical Theology	
Edwards	60	General Studies	17, 59
General Studies	30	Homiletics	28
Luther and Calvin	30	Holy Spirit - Systematic Theology	
Medieval Era	19	Anthropology and Ecclesiology	59
Creation	23	Biblical Theology	17
Ecclesiology	34	Contemporary Evangelicalism and Mission	18
Evangelical Philosophical Society		Evangelism and Apologetics	40
Business Meeting	52	General Studies	29, 59
Plenary Session	42	Hermeneutics	18
Sessions	15, 26 – 27, 38 – 39, 48 – 49, 58	Sanctification	49
Evangelical Theological Society		Soteriology	60
Banquet	52	The Trinity	29
Business Meeting	52		

Session Index

Inerrancy of Scripture	44	Pentateuch	20, 62
Islam & Evangelical Christianity	44	Psalms	20
Johannine Literature		Old Testament Backgrounds / Ancient Near East	
Open Session	54	Comparative Methodology	14
Unity and Diversity	13	Cultic Law in the OT and Ancient Near East	36
Karl Barth, the Holy Spirit, and Pentecostal Systematic		Old Testament Narrative Literature	
Theology	60	Narrative Criticism	45
Letter to the Hebrews	44	Open Session	25
Luke / Acts		Old Testament Prophetic and Apocalyptic Books	
Contemporary Reflections on the Holy Spirit in Acts ..	54	Zephaniah -Malachi	36
Open Session	24	Zephaniah, Haggai, Zechariah, and Malachi	55
Messianic Jewish Studies	54	Old Testament Theology	
Method in Systematic Theology		Canon and Canonical Reading	45
How Global Can Evangelical Theology Be?	35	Legacy of Willem VanGemeren	25
Theological Method	24	Old Testament Wisdom Literature	55
Mini-Workshop for Early-Career Faculty on Assessing		Pastoral Epistles	36
Teaching and Learning	42	Patristic and Medieval History	
Models of God	54	Blessedness and Grace, Buildings and Manuscripts	25
Near East Archaeological Society		The Holy Spirit in Patristic Thought	45
Business Meeting	42	Paul's Letter to the Romans	36
Sessions	15, 27, 39, 49, 58	Pauline Studies	
New Testament		Open Session	56
Acts	19	Scripture in Romans & 1 Corinthians	46
General Studies	61	Pentateuch	
Johannine Literature	30	Kingship in the Pentateuch	37
Matthew	30	Open Session	46
Pauline Literature	40, 50, 61	Perspectives on the Spiritual Gifts	20
Synoptics	31	Practical Theology	
New Testament Canon, Text Criticism & Apocryphal Lit.		Beauty	31
Open Session	44	Care and Counseling	51
The Holy Spirit	55	General Studies	21, 51
New Testament Greek Language and Exegesis		Pastoral Leadership	41
Open Session	35	Progressive Covenantalism	51
The Letter to the Romans	24	Psalms and Hebrew Poetry	
Old Testament		Canonical Studies in the Psalms after Thirty Years	46
General Studies	19	Open Session	26
Historical Books	50	Public Theology	56
Isaiah and Jeremiah	20	Reflections on Michael Horton's <i>Rediscovering the Holy</i>	
Minor Prophets and Daniel	31	<i>Spirit</i>	50
OT Theology and Hermeneutics	61	Reformation Studies	

Session Index

A Symposium on the 400th Anniversary of Dort.....	37
Dort and Westminster (1618-1648)	47
Retrieving Eternal Procession	31
Septuagint Studies	47
Spiritual Formation / Sanctification	
Spiritual Formation and Holy Spirit	47
Spiritual Formation, Spirit & Virtue	37
Synoptic Gospels.....	14, 26
Systematic Theology	
Anthropology	41
Biblical Theology	21
Christology	21
General Studies	41, 52, 62
Social Justice and Ecclesiology	22
Social Justice and Reconciliation	62
Theology Proper and Impassibility.....	22
The Book of Revelation	56
The Creation Project	52
The Holy Spirit, the Power of God, and the Future of Evangelical Theology	40
The Nashville Statement	32
Theological Education and Pedagogy	56
Theology for Counseling and Pastoral Care	14, 26
Trinitarian Theology	57
Voices in American Theology and Culture	48
Warfare and Violence in the Old Testament	57
Wesleyan Studies	38

Past Presidents 1962 – 2017*

1962	Ralph Earle Nazarene Seminary	1983	Louis Goldberg Moody Bible Institute	2002	Millard J. Erickson George W. Truett Theological Seminary, Baylor University
1963	Vernon Grounds Conservative Baptist Seminary	1984	W. Haddon Robinson Denver Seminary	2003	David M. Howard Jr. Bethel Theological Seminary
1964	Burton Goddard Gordon Divinity School	1985	Richard V. Pierard Indiana State University	2004	Gregory K. Beale Wheaton College
1965	Gordon Clark Butler University	1986	Gleason L. Archer Jr. Trinity Evangelical Divinity School	2005	Craig A. Blaising Southwestern Baptist Theological Seminary
1966	J. Barton Payne Wheaton College	1987	Walter M. Dunnnett Northwestern College	2006	Edwin M. Yamauchi Miami University of Ohio
1967	Stephen Paine Houghton College	1988	Elmer B. Smick Gordon-Conwell Theological Seminary	2007	Francis Beckwith (resigned) Baylor University
1968	Kenneth Kantzer Trinity Evangelical Divinity School	1989	James A. Borland Liberty Baptist Theological Seminary	2008	C. Hassell Bullock Wheaton College
1969	Carl F. H. Henry Eastern Baptist Theological Seminary	1990	Robert L. Thomas The Master's Seminary	2009	Bruce A. Ware The Southern Baptist Theological Seminary
1970	Robert Cooley Evangel College	1991	H. Wayne House Dallas Theological Seminary	2010	Eugene H. Merrill Dallas Theological Seminary
1971	Harold Lindsell Christianity Today	1992	Gordon R. Lewis Denver Seminary	2011	Clinton E. Arnold Talbot School of Theology
1972	Robert L. Saucy Talbot Seminary	1993	Gerry Breshears Western Conservative Baptist Seminary	2012	Paul R. House Beeson Divinity School
1973	Arthur H. Lewis Bethel College	1994	L. Russ Bush Southeastern Baptist Seminary	2013	Robert W. Yarbrough Covenant Theological Seminary
1974	Richard Longenecker Wycliffe College	1995	George W. Knight, III Knox Theological Seminary	2014	Thomas R. Schreiner The Southern Baptist Theological Seminary
1975	Bruce K. Waltke Dallas Theological Seminary	1996	Robert C. Newman Biblical Theological Seminary	2015	Scott B. Rae Talbot School of Theology
1976	Simon J. Kistemaker Reformed Theological Seminary	1997	Moisés Silva Gordon-Conwell Theological Seminary	2016	Daniel B. Wallace Dallas Theological Seminary
1977	Walter C. Kaiser Jr. Trinity Evangelical Divinity School	1998	Norman L. Geisler Southern Evangelical Seminary	2017	Sam Storms Bidgeway Church / Enjoying God Ministries
1978	Stanley N. Gundry Moody Bible Institute	1999	Wayne A. Grudem Trinity Evangelical Divinity School		
1979	Marten H. Woudstra Calvin Theological Seminary	2000	John H. Sailhamer Southeastern Baptist Theological Seminary		
1980	Wilber B. Wallis Covenant Theological Seminary	2001	Darrell L. Bock Dallas Theological Seminary		
1981	Kenneth L. Barker Dallas Theological Seminary				
1982	Alan F. Johnson Wheaton College				

* For a complete listing of past presidents:
www.etsjets.org/Presidents

Past Conferences 1979 – 2017*

1979	Bethel College St. Paul, MN <i>Hermeneutics for the '80's</i>	1992	San Francisco Airport Hilton San Francisco, CA <i>The Strategy for the Church in the '90s</i>	2006	Washington Hilton Hotel Washington, DC <i>Christians in the Public Square</i>
1980	Columbia Bible College Columbia, SC <i>Evangelicals and Social Ethics</i>	1993	McLean Hilton McLean, VA <i>God and Caesar</i>	2007	Town & Country Resort San Diego, CA <i>Teaching Them to Obey</i>
1981	Ontario Theological Seminary Toronto, ON <i>Relationships Between the Testaments</i>	1994	Lisle-Naperville Hilton Lisle, IL <i>Hermeneutics: Issues and Concerns</i>	2008	Rhode Island Convention Center Providence, RI <i>Text and Canon</i>
1982	Northeastern Bible College Essex Fells, NJ <i>Biblical Criticism and the Evangelical</i>	1995	Airport Radisson Philadelphia, PA <i>Defending the Faith: Christian Apologetics in a Non-Christian World</i>	2009	New Orleans Sheraton New Orleans, LA <i>Personal & Social Ethics</i>
1983	Criswell Center for Biblical Studies Dallas, TX <i>Preaching and Biblical Exegesis</i>	1996	Harvey Hotel Jackson, MS <i>The Holy Spirit: His Presence, Ministry, and Gifts</i>	2010	Atlanta Hilton Atlanta, GA <i>Justification by Faith</i>
1984	Moody Bible Institute Chicago, IL <i>Evangelicals: Heritage and Rediscovery</i>	1997	Westin Hotel Santa Clara, CA <i>General Revelation</i>	2011	San Francisco Marriott Marquis San Francisco, CA <i>No Other Name</i>
1985	Talbot School of Theology La Mirada, CA <i>Church and Society</i>	1998	Radisson Twin Towers Orlando, FL <i>Teaching Them All Things</i>	2012	Delta Center Milwaukee, WI <i>Caring for Creation</i>
1986	Rehoboth Baptist Church Tucker, GA <i>Male and Female in Biblical and Theological Perspective</i>	1999	Sheraton Ferncroft Resort Danvers, MA <i>Eschatology</i>	2013	Hilton Baltimore Baltimore, MD <i>Evangelicalism, Inerrancy, and ETS</i>
1987	Gordon-Conwell Theological Seminary South Hamilton, MA <i>Evangelicals and Spirituality</i>	2000	Opryland Hotel Nashville, TN <i>Israel: Past, Present, and Future</i>	2014	Town and Country Resort San Diego, CA <i>Ecclesiology</i>
1988	Wheaton College Wheaton, IL <i>Evangelicals and Cross-Cultural Communication</i>	2001	Broadmoor Hotel Colorado Springs, CO <i>Defining Evangelicalism's Boundaries</i>	2015	Hilton Atlanta Atlanta, GA <i>Marriage and the Family</i>
1989	Bethel Theological Seminary-West San Diego, CA <i>The Gospel and World Religions</i>	2002	Regal Constellation Hotel Toronto, ON <i>Evangelical Christianity & Other Religions</i>	2016	Grand Hyatt and Marriott Rivercenter San Antonio, TX <i>The Trinity</i>
1990	New Orleans Baptist Theological Seminary New Orleans, LA <i>Morality and Ethics</i>	2003	Hilton Atlanta Atlanta, GA <i>Jesus</i>	2017	Rhode Island Convention Center Providence, RI <i>The Heritage of the Reformation</i>
1991	Airport Hilton Plaza Inn Kansas City, MO <i>Christ and the Kingdom in the Old and New Testaments</i>	2004	San Antonio J. W. Marriott San Antonio, TX <i>What Is Truth?</i>		
		2005	Valley Forge Convention Center Valley Forge, PA <i>Christianity in the Early Centuries</i>		

* For a complete listing of past conferences:
www.etsjets.org/Conferences



David S. Dockery, President
Trinity Evangelical Divinity School
and Trinity International University
President of the ETS, 2018

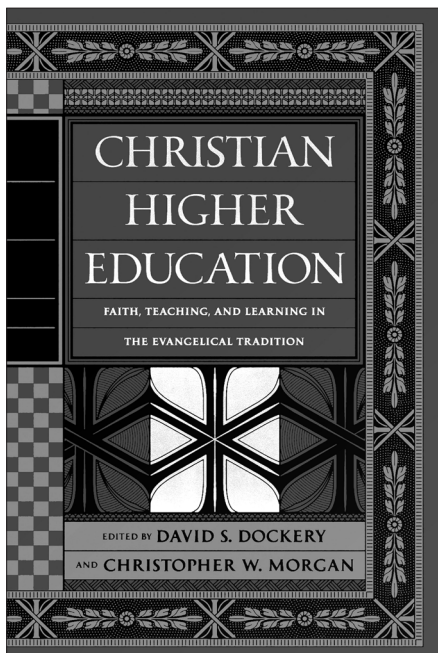

Trinity is pleased to announce the release of *Christian Higher Education: Faith, Teaching, and Learning in the Evangelical Tradition*, edited by David S. Dockery and Christopher W. Morgan and published by Crossway. This collection of essays by leading scholars explains the foundational beliefs about God, knowledge, and humanity that underlie Christian higher education, and demonstrates how the Christian tradition shapes approaches to teaching, learning, scholarship, and practice. This resource will equip Christian teachers and students to more effectively engage the broader culture and lead both church and society, for the good of the world and the glory of God.

Please join us for the **Trinity Alumni & Friends Dessert Reception**, an opportunity for students, faculty, and alumni to gather
Wednesday evening | November 14 | 9:15-11 PM
Windows in the IMP Sheraton Tower



teds.edu/ets

2065 Half Day Road | Village of Bannockburn | Deerfield, IL 60015 | 800.345.8337
ENTRUSTED WITH THE GOSPEL TO SERVE THE GLOBAL CHURCH

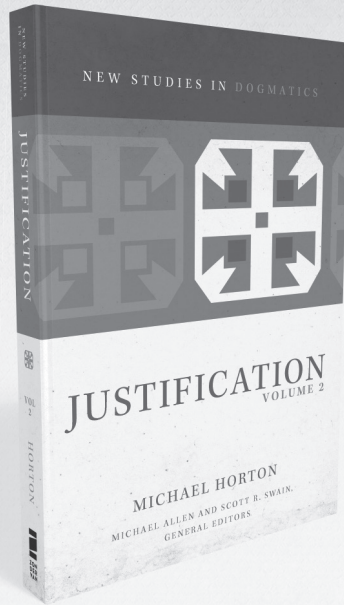
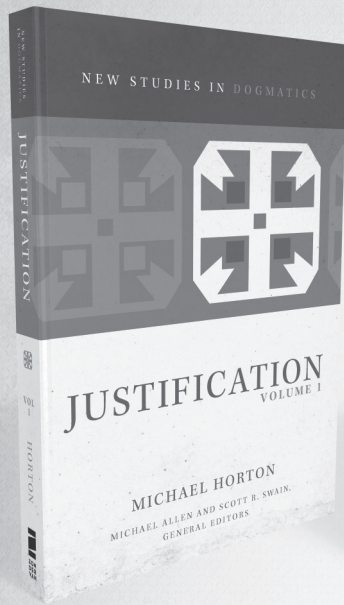

Justification Volumes 1 and 2

by Michael Horton

NEW STUDIES IN DOGMATICS

Only **\$38.25**

when purchased as a set.

Justification, Volume 1

Michael Horton
9780310491606
Softcover • 400 pp.
LIST PRICE \$39⁹⁹

Justification, Volume 2

Michael Horton
9780310578383
Softcover • 512 pp.
LIST PRICE \$44⁹⁹

SAVE 55%

Available for on-site purchases only.

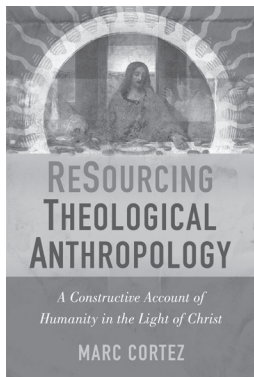

**ReSourcing
Theological
Anthropology**
A Constructive Account of
Humanity in the Light of Christ
MARC CORTEZ
LIST \$29⁹⁹ SALE \$17⁹⁹

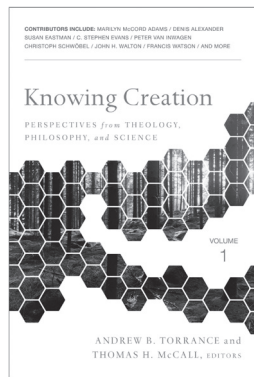

Knowing Creation
PERSPECTIVES FROM THEOLOGY,
PHILOSOPHY, AND SCIENCE
VOLUME 1
ANDREW B. TORRANCE and
THOMAS H. MCCALL, EDITORS
LIST \$39⁹⁹ SALE \$23⁹⁹

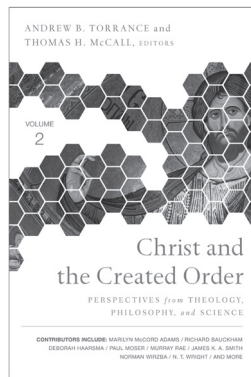

**Christ and
the Created Order**
PERSPECTIVES FROM THEOLOGY,
PHILOSOPHY, AND SCIENCE
VOLUME 2
ANDREW B. TORRANCE and
THOMAS H. MCCALL, EDITORS
LIST \$36⁹⁹ SALE \$22¹⁹

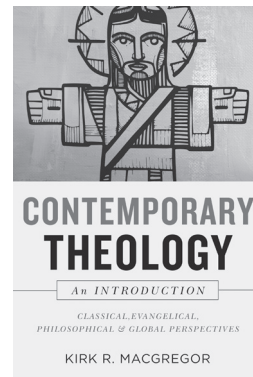

**Contemporary Theology:
An Introduction**
CLASSICAL, EVANGELICAL,
PHILOSOPHICAL & GLOBAL PERSPECTIVES
KIRK R. MACGREGOR
LIST \$34⁹⁹ SALE \$20⁹⁹
Coming January 2019

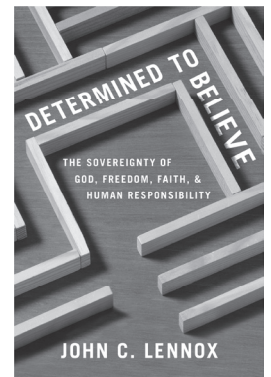

Determined to Believe?
THE SOVEREIGNTY OF
GOD, FREEDOM, FAITH, &
HUMAN RESPONSIBILITY
JOHN C. LENNOX
LIST \$19⁹⁹ SALE \$11⁹⁹

For a complete list of all the NEW books that are available at the Zondervan booth at ETS visit ZondervanAcademic.com/ETSprogramads

**40% DISCOUNT ON ALL RESOURCES
PLUS, FREE SHIPPING ON ALL ORDERS!**

(Available for US orders only)

TWO WAYS TO ORDER

ORDER IN THE BOOTH (#201)

- Instant processing
- Take with you or ship right away
- Get onsite only specials

ORDER BEFORE OR AFTER ETS

- Use source code Z18ETS
- 1-800-727-3480 or ChurchSource.com
- Offer ends 12/31/18

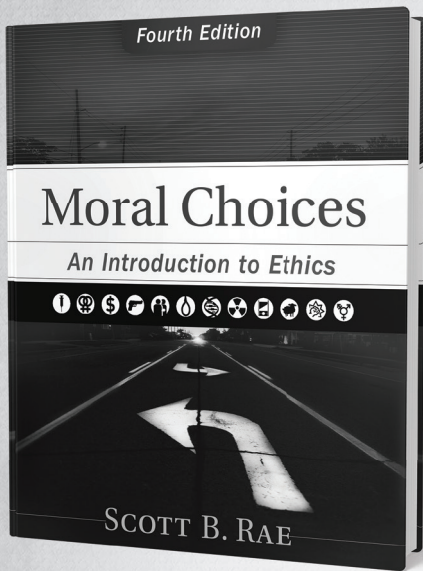

Interested in adopting the new edition of *MORAL CHOICES*?

Want to find out more about it?

Sign up for a group consultation with SCOTT RAE during ETS!

THREE TIMES AVAILABLE:

- Tuesday, 11/13 | 10:15-10:45 am
- Wednesday, 11/14 | 2:00-2:30 pm
- Thursday, 11/15 | 11:30 am-noon

Moral Choices, Fourth Edition

Scott B. Rae
9780310536420
Hardcover • 496 pp.
LIST \$39⁹⁹ SALE \$23⁹⁹



Each consultation time includes a brief presentation from the author about what is new in the book and time for Q&A about new features, content, classroom use, etc.

Space is limited. Sign up today at bit.ly/mcconsult

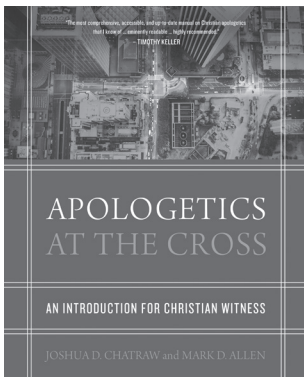

Apologetics at the Cross
Joshua D. Chatraw and Mark D. Allen
9780310524687
Hardcover • 336 pp.
LIST \$34⁹⁹ SALE \$20⁹⁹

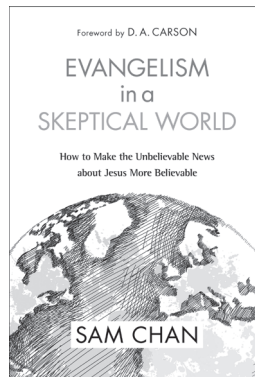

Evangelism in a Skeptical World
Sam Chan
9780310534679
Hardcover • 288 pp.
LIST \$24⁹⁹ SALE \$14⁹⁹

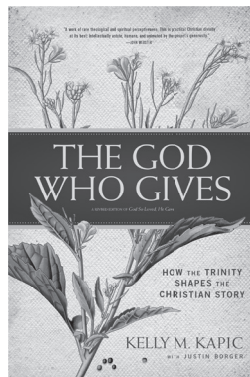

The God Who Gives
Kelly M. Kapic
9780310520269
Softcover • 288 pp.
LIST \$22⁹⁹ SALE \$13⁹⁹

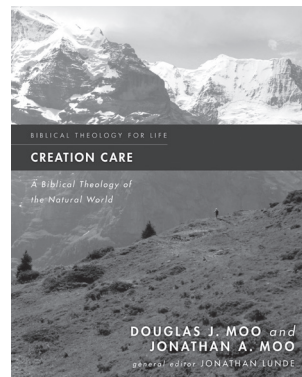

Creation Care
Douglas J. Moo and Jonathan A. Moo
9780310293743
Softcover • 256 pp.
LIST \$24⁹⁹ SALE \$14⁹⁹

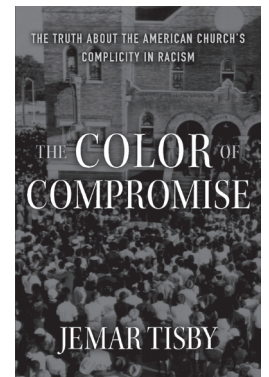

The Color of Compromise
Jemar Tisby
9780310597261
Hardcover • 224 pp.
LIST \$21⁹⁹ SALE \$13⁹⁹
Coming January 2019

For a complete list of all the NEW books that are available at the Zondervan booth at ETS visit ZondervanAcademic.com/ETSprogramads

40% DISCOUNT ON ALL RESOURCES PLUS, FREE SHIPPING ON ALL ORDERS!
(Available for US orders only)

TWO WAYS TO ORDER

ORDER IN THE BOOTH (#201)

- Instant processing
- Take with you or ship right away
- Get onsite only specials

ORDER BEFORE OR AFTER ETS

- Use source code Z18ETS
- 1-800-727-3480 or ChurchSource.com
- Offer ends 12/31/18

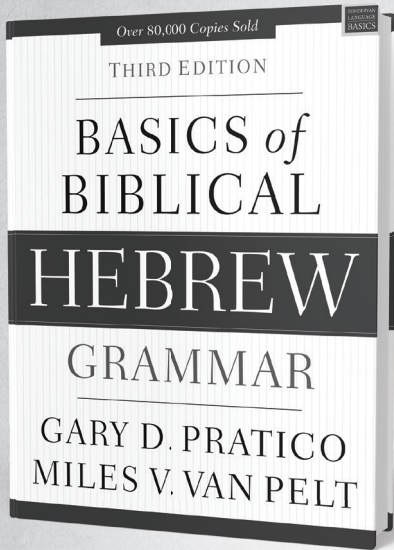

Coming February 2019

Interested in adopting the new edition of *BASICS OF BIBLICAL HEBREW*?

Want to find out more about it?

Sign up for a group consultation with MILES VAN PELT during ETS!

THREE TIMES AVAILABLE:

- Tuesday, 11/13 | 9:30-10:00 am
- Wednesday, 11/14 | 3:30-4:00 pm
- Thursday, 11/15 | 1:30-2:00 pm

Basics of Biblical Hebrew Grammar, Third Edition

Gary D. Pratico and Miles V. Van Pelt
9780310533498

Hardcover • 480 pp.

LIST \$59⁹⁹ **SALE \$35⁹⁹**



Each consultation time includes a brief presentation from the author about what is new in the book and time for Q&A about new features, content, classroom use, etc.

Space is limited. Sign up today at bit.ly/bbh3consult

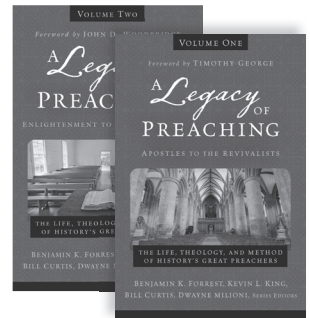
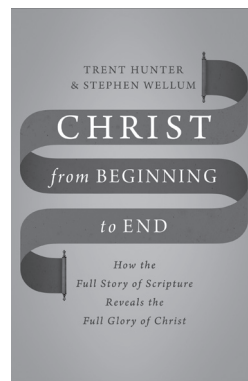
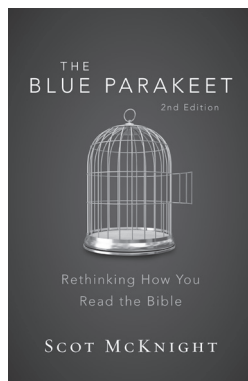
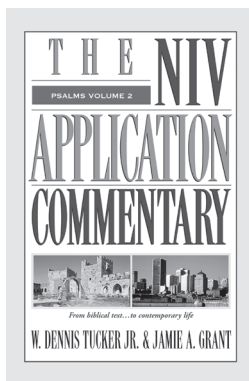
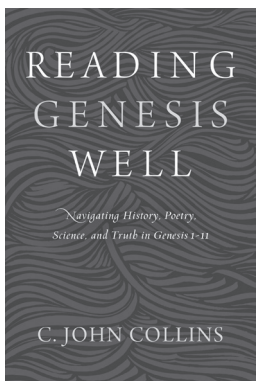

Reading Genesis Well

C. John Collins
9780310598572
Softcover • 320 pp.

LIST \$36⁹⁹ **SALE \$22¹⁹**

Psalms, Volume 2

W. Dennis Tucker Jr. and
Jamie A. Grant
9780310206705
Hardcover • 1056 pp.

LIST \$64⁹⁹ **SALE \$38⁹⁹**

The Blue Parakeet, 2nd Edition

Scot McKnight
9780310538929
Softcover • 336 pp.

LIST \$19⁹⁹ **SALE \$11⁹⁹**

Christ from Beginning to End

Trent Hunter and Stephen
Wellum

9780310536543
Hardcover • 288 pp.

LIST \$22⁹⁹ **SALE \$13⁷⁹**

A Legacy of Preaching

L. King, William J. Curtis,
Dwayne Milioni, Series Editors

Volume One—Apostles to the Revivalists

9780310538226
Hardcover • 544 pp.

Volume Two—Enlightenment to the Present Day

9780310538264
Hardcover • 400 pp.

LIST \$49⁹⁹ **SALE \$29⁹⁹**

For a complete list of all the NEW books that are available at the Zondervan booth at ETS visit ZondervanAcademic.com/ETSprogramads

40% DISCOUNT ON ALL RESOURCES PLUS, FREE SHIPPING ON ALL ORDERS!

(Available for US orders only)

TWO WAYS TO ORDER

ORDER IN THE BOOTH (#201)

- Instant processing
- Take with you or ship right away
- Get onsite only specials

ORDER BEFORE OR AFTER ETS

- Use source code Z18ETS
- 1-800-727-3480 or ChurchSource.com
- Offer ends 12/31/18

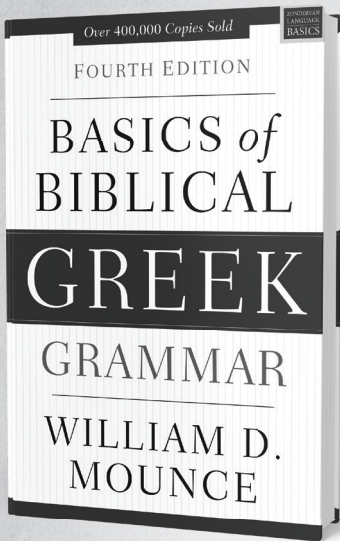

Coming February 2019

Basics of Biblical Greek Grammar, Fourth Edition

William D. Mounce
9780310537434
Hardcover • 496 pp.

LIST \$59⁹⁹ SALE \$35⁹⁹



Each consultation time includes a brief presentation from the author about what is new in the book and time for Q&A about new features, content, classroom use, etc.

Space is limited. Sign up today at bit.ly/bbg4consult

THREE TIMES AVAILABLE:

- Tuesday, 11/13 | 11:00-11:30 am
- Wednesday, 11/14 | 2:45-3:15 pm
- Thursday, 11/15 | 2:15-2:45 pm

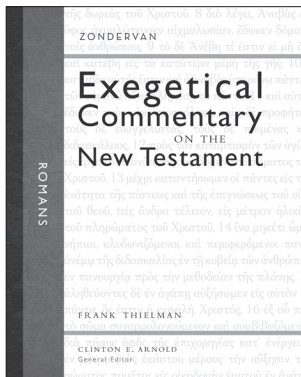

Romans

Frank Thielman
9780310243687
Hardcover • 816 pp.

LIST \$59⁹⁹ SALE \$35⁹⁹

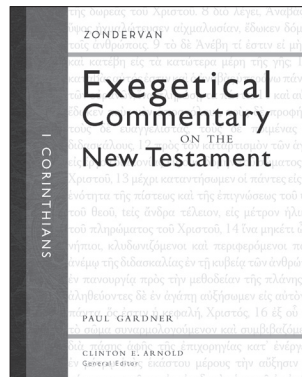

1 Corinthians

Paul Gardner
9780310243694
Hardcover • 816 pp.

LIST \$49⁹⁹ SALE \$29⁹⁹

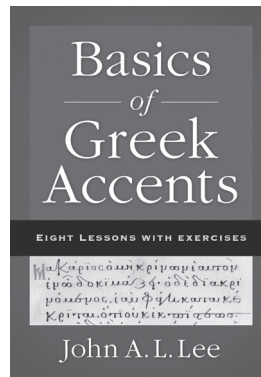

Basics of Greek Accents

John A. L. Lee
9780310555643
Softcover • 112 pp.

LIST \$14⁹⁹ SALE \$8⁹⁹

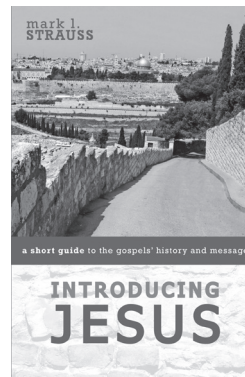

Introducing Jesus

Mark L. Strauss
9780310528586
Softcover • 192 pp.

LIST \$16⁹⁹ SALE \$10¹⁹

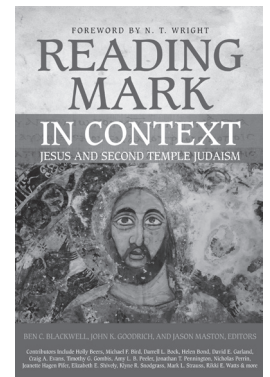

Reading Mark in Context

Ben C. Blackwell, John K. Goodrich, and Jason Maston, Editors
9780310534457
Softcover • 288 pp.

LIST \$24⁹⁹ SALE \$14⁹⁹

For a complete list of all the NEW books that are available at the Zondervan booth at ETS visit ZondervanAcademic.com/ETSprogramads

40% DISCOUNT ON ALL RESOURCES PLUS, FREE SHIPPING ON ALL ORDERS!

(Available for US orders only)

TWO WAYS TO ORDER

ORDER IN THE BOOTH (#201)

- Instant processing
- Take with you or ship right away
- Get onsite only specials

ORDER BEFORE OR AFTER ETS

- Use source code Z18ETS
- 1-800-727-3480 or ChurchSource.com
- Offer ends 12/31/18

Classical Theism

Answering modern

philosophical

“problems” before

modern thinkers

even thought to ask

the wrong questions.



**SOUTHERN
EVANGELICAL**
Seminary & Bible College

B.A. | M.A. | M.Div. | Th.M. | D.Min. | Ph.D.

Learn more and *have your application fee waived* when you apply at

www.SES.edu/EPSETS

50% OFF + FREE SHIPPING* ON NEW RELEASES!

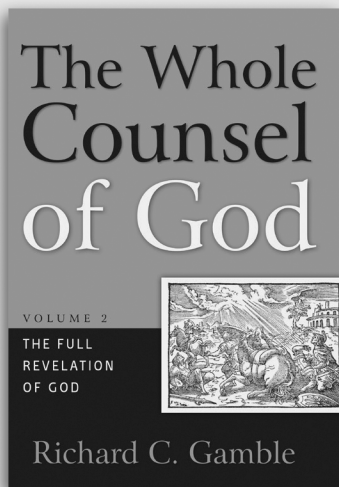

NEW FROM RICHARD GAMBLE

"The fruit of decades of scholarship, teaching, preaching, fellowship, and life in Christ, this continuation of Professor Gamble's survey of God's mighty acts is impressive. The author provides amazing and sweeping vistas of the forest without neglecting the trees. This volume will reward patient reading and rereading."

—MICHAEL S. HORTON

A comprehensive theological tool—combining biblical, systematic, and historical theology—that surveys the entire New Testament with themed discussions and a focus on God's revelation and exaltation in Christ.

978-1-59638-181-0 | 6" x 9" | Cloth | 1144 Pages | \$59.99

NEW SERIES

"When I was beginning my studies of theology and philosophy during the 1950s and '60s, I profited enormously from P&R's Modern Thinkers Series. Today, P&R is resuming and updating the series, now called Great Thinkers. Written by scholars who are experts on these writers. . . I look forward to the release of all the books being planned and to the good influence they will have on the next generation of philosophers and theologians."

—JOHN M. FRAME

Writing from a Reformed perspective, the series's authors identify the most influential cultural features of each great thinker and the most apologetically effective ways to address these.

978-1-62995-221-5 | 6" x 9" | Paper | 192 Pages | \$14.99

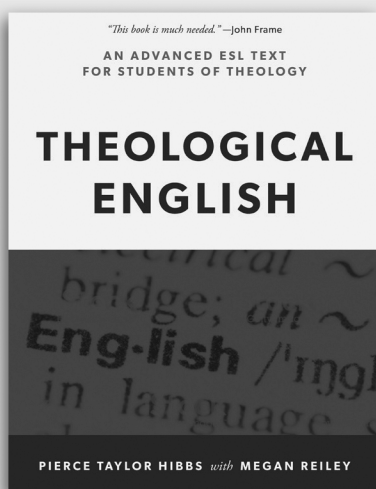
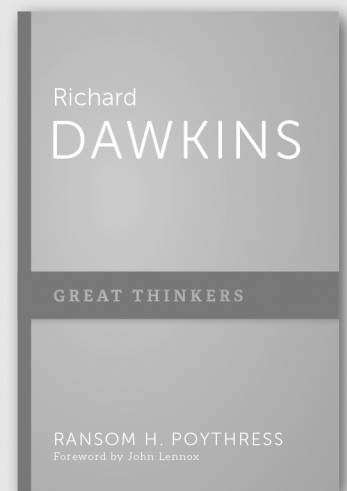

NEW ESL TEXTBOOK

"A most welcome one-of-a-kind volume, *Theological English* offers a compelling introduction to theology, while effectively building the reader's mastery of the English language. Though the book is marvelously useful for non-native English speakers, any budding student of theology will significantly profit from the language skills absorbed along this reverent theological pilgrimage. *Tolle lege!*"

—DAVID B. GARNER

Prepares non-native English speakers to study theology in English at an advanced level. Lessons cover the major theological genres, and practical exercises develop reading, listening, speaking, and writing skills.

978-1-62995-602-2 | 8.5" x 11" | Casebound | 376 Pages | \$49.99

Visit booth #217 to learn more about our 50% off plus free shipping special. *continental US shipping only

GO DEEPER WITH MIDWESTERN DOCTORAL

**MIDWESTERN SEMINARY'S DOCTORAL
DEGREE PROGRAMS ARE DESIGNED TO EQUIP
AND TRAIN LEADERS FOR THE CHURCH.**

All of Midwestern Seminary's doctoral degrees are perfect for students seeking a high level of professional and academic competence. Whether you're pursuing your PhD, DMin, DCoun, DEdMin, or ThM, we offer multiple concentrations. Because all of our doctoral programs are modular, you don't even have to leave your current context to prepare for greater ministry impact.

Take the next step.

mbts.edu/ets

AFFORDABLE

One of the most competitive tuition rates in the country.

FLEXIBLE

Stay where you are or study with us here in Kansas City.

PRACTICAL

Choose from four degrees with more than 20 concentrations.

UNDERGRADUATE GRADUATE ▶ DOCTORAL ONLINE

🐦 @MBTS | [MBTS.EDU](http://mbts.edu) | 816-414-3733 | KANSAS CITY, MO



for the Church

MIDWESTERN
BAPTIST THEOLOGICAL SEMINARY



McMaster Divinity College

Doctor of Philosophy (Christian Theology)
Doctor of Practical Theology
Master of Arts (Christian Studies)

MDiv
MTS

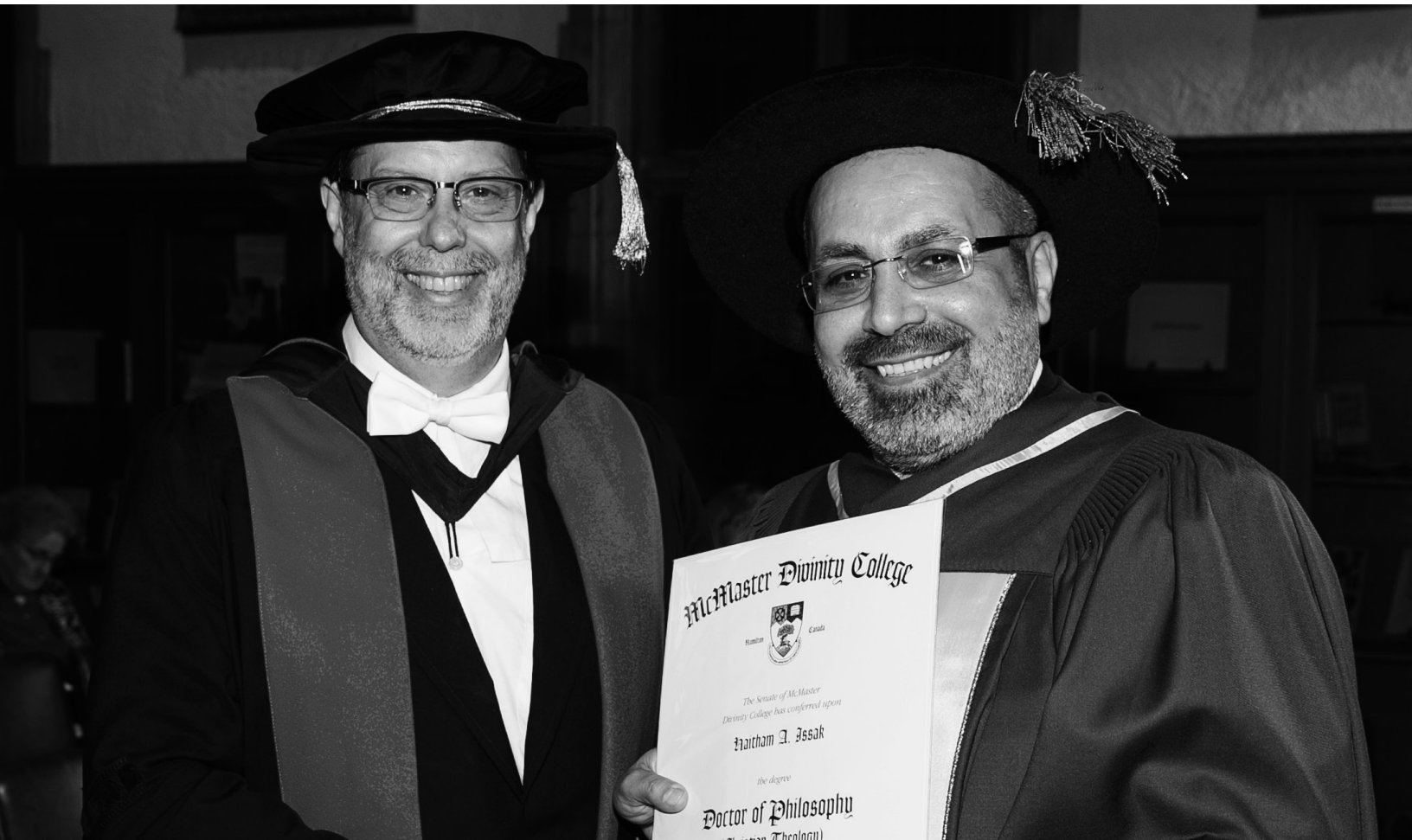

Knowing...
the word of God



Being...
transformed into Christ's image



Doing...
the work of ministry

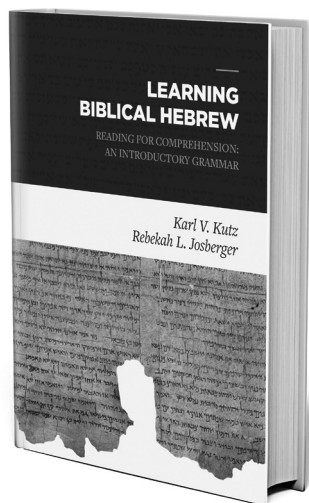

Learning Biblical Hebrew

*Reading for Comprehension:
An Introductory Grammar*

Karl Kutz and Rebekah Josberger
9781683590842
Hardcover • 368 pages
SALE \$19.99

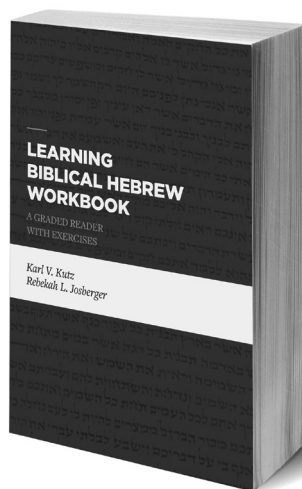

Learning Biblical Hebrew Workbook

A Graded Reader with Exercises

Karl Kutz and Rebekah Josberger
9781683592440
Softcover • 256 pages
SALE \$9.99

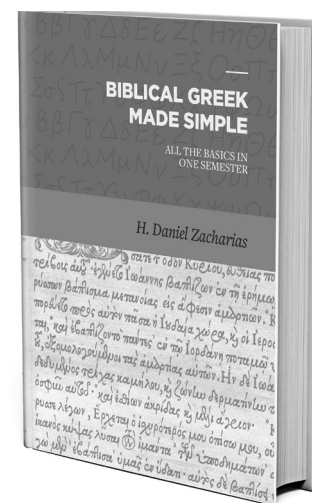

Biblical Greek Made Simple

All the Basics in One Semester

H. Daniel Zacharias
9781683591009
Hardcover • 176 pages
SALE \$14.49

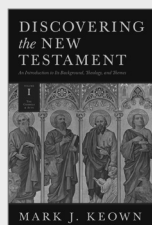

Discovering the New Testament

*An Introduction to Its Background,
Theology, and Themes: Vol. 1, The
Gospels and Acts*

Mark Keown
9781683592327
Hardcover • 632 pages
SALE \$24.99

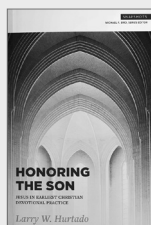

Honoring the Son

*Jesus in Earliest Christian
Devotional Practice*

Larry W. Hurtado
9781683590965
Softcover • 95 pages

SPECIAL OFFER
SALE \$5.00

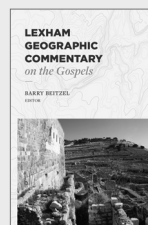

Lexham Geographic Commentary on the Gospels

Barry Beitzel, Editor
9781683590446
Hardcover • 600 pages
SALE \$19.99

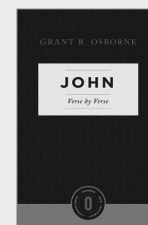

John Verse by Verse

Osborne New Testament Commentaries

Grant R. Osborne
9781683590750
Softcover • 432 pages
SALE \$12.99

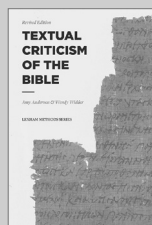

Textual Criticism of the Bible

Lexham Methods Series

Amy Anderson and
Wendy Widder
9781577996637
Softcover • 264 pages
SALE \$12.49

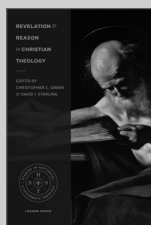

Revelation and Reason in Christian Theology

David I. Starling and
Christopher C. Green, Editors
9781683590989
Softcover • 240 pages
SALE \$11.49



The Beauty of the Lord

Theology as Aesthetics

Jonathan King
9781683590583
Softcover • 424 pages
SALE \$12.49

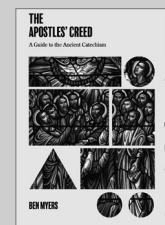

The Apostles' Creed

A Guide to the Ancient Catechism

Ben Myers
9781683590880
Hardcover • 112 pages
SALE \$7.99

Visit Booth #219 for a 50% discount on all books, and free shipping on mail orders (US only).

To order before or after ETS, use coupon code **LEXETS50** at Lexhampress.com. Offer good through Dec. 31, 2018.

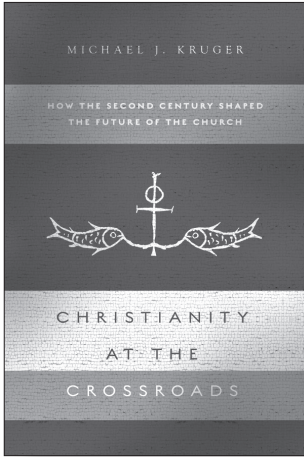

CHRISTIANITY AT THE CROSSROADS, Michael J. Kruger, \$30.00

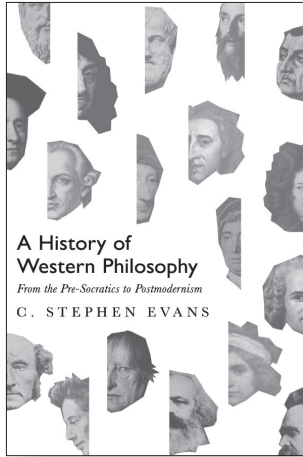

A HISTORY OF WESTERN PHILOSOPHY, C. Stephen Evans, \$60.00

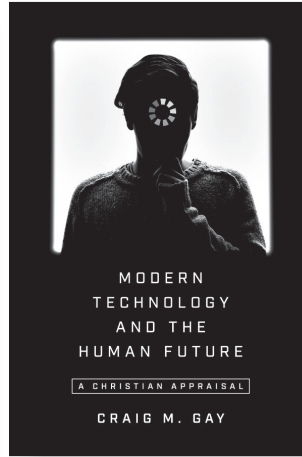

MODERN TECHNOLOGY AND THE HUMAN FUTURE, Craig M. Gay, \$25.00

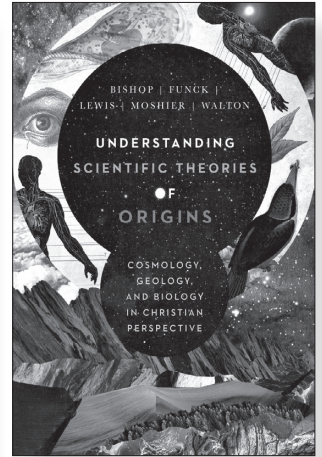

UNDERSTANDING SCIENTIFIC THEORIES OF ORIGINS, Robert C. Bishop, Larry L. Funk, Raymond J. Lewis, Stephen O. Moshier, and John H. Walton, \$75.00

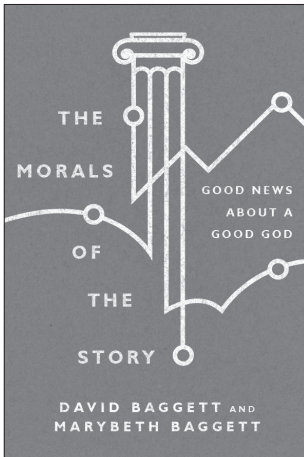

THE MORALS OF THE STORY, David Baggett and Marybeth Baggett, \$26.00

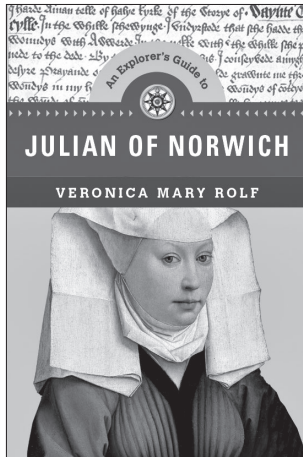

AN EXPLORER'S GUIDE TO JULIAN OF NORWICH, Veronica Mary Rolf, \$18.00

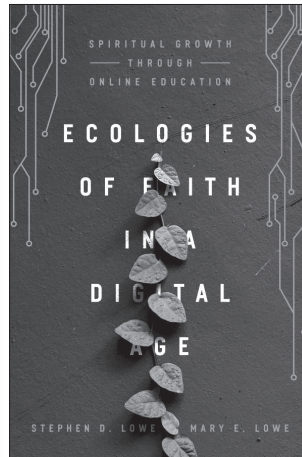

ECOLOGIES OF FAITH IN A DIGITAL AGE, Stephen D. Lowe and Mary E. Lowe, \$25.00

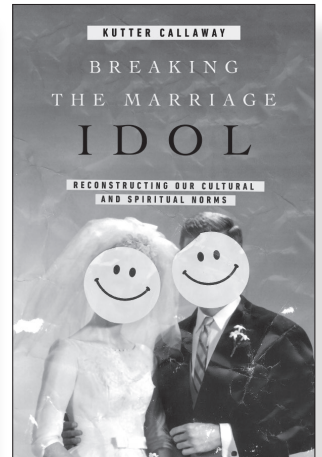

BREAKING THE MARRIAGE IDOL, Kutter Callaway, \$18.00

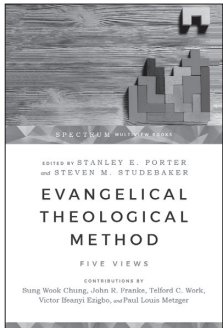

EVANGELICAL THEOLOGICAL METHOD, edited by Stanley E. Porter and Steven M. Studebaker, \$25.00

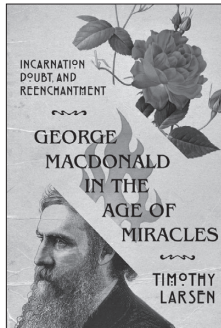

GEORGE MACDONALD IN THE AGE OF MIRACLES, Timothy Larsen, \$16.00

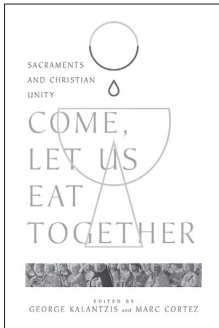

COME, LET US EAT TOGETHER, edited by George Kalantzis and Marc Cortez, \$26.00

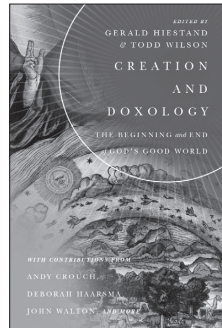

CREATION AND DOXOLOGY, edited by Gerald L. Hiestand and Todd Wilson, \$25.00

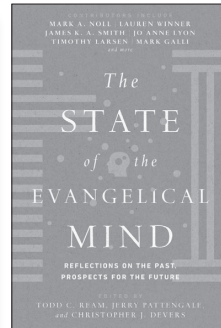

THE STATE OF THE EVANGELICAL MIND, edited by Todd C. Ream, Jerry Pattengale, and Christopher J. Devers, \$28.00

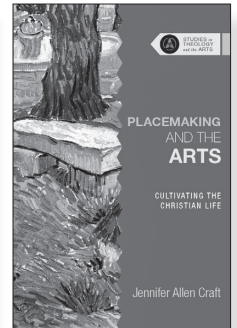

PLACEMAKING AND THE ARTS, Jennifer Allen Craft, \$30.00

Visit Booth #323 for a 40% DISCOUNT

IVP ACADEMIC

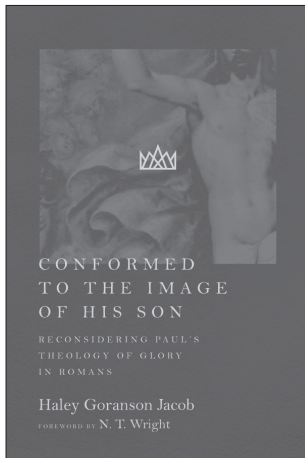
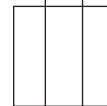

CONFORMED TO THE IMAGE OF HIS SON, Haley Goranson Jacob, \$32.00

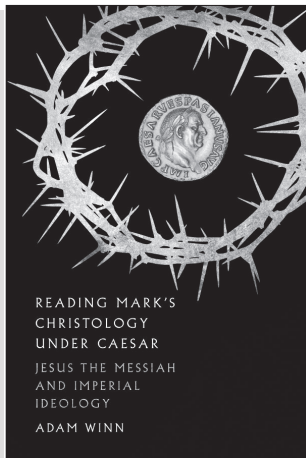

READING MARK'S CHRISTOLOGY UNDER CAESAR, Adam Winn, \$24.00

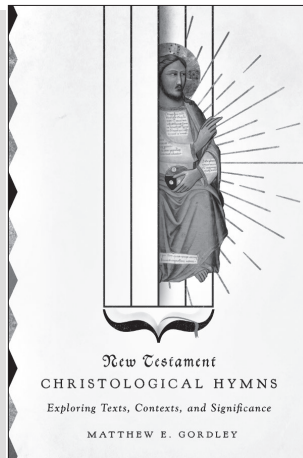

NEW TESTAMENT CHRISTOLOGICAL HYMNS, Matthew E. Gordley, \$28.00

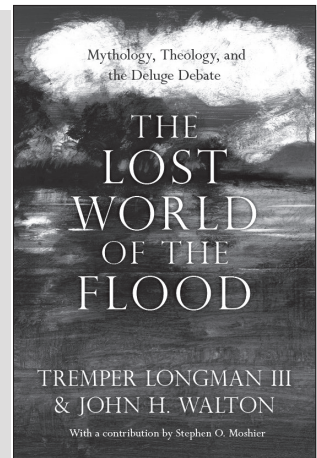

THE LOST WORLD OF THE FLOOD, Tremper Longman III and John H. Walton with Stephen O. Moshier, \$18.00

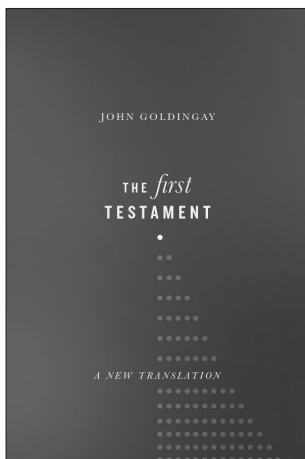

THE FIRST TESTAMENT, John Goldingay, \$60.00

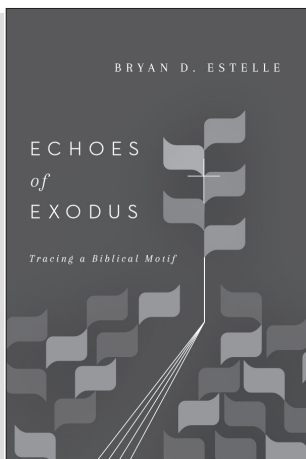

ECHOES OF EXODUS, Bryan D. Estelle, \$40.00

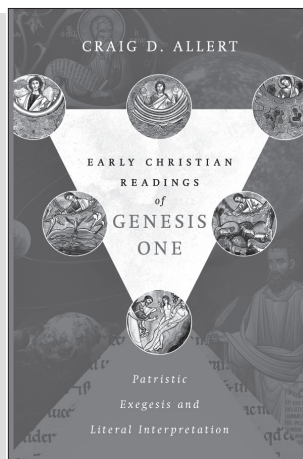

EARLY CHRISTIAN READINGS OF GENESIS ONE, Craig D. Allert, \$36.00

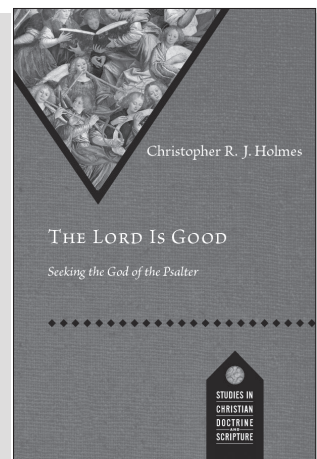

THE LORD IS GOOD, Christopher R. J. Holmes, \$27.00

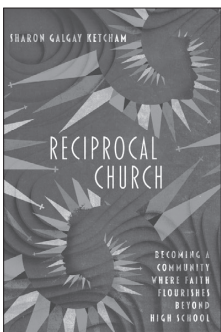

RECIPROCAL CHURCH, Sharon Galgay Ketcham, \$17.00

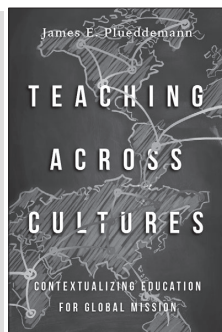

TEACHING ACROSS CULTURES, James E. Plueddemann, \$20.00

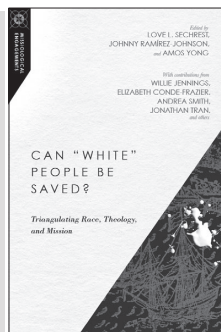

CAN "WHITE" PEOPLE BE SAVED?, edited by Love L. Sechrest, Johnny Ramirez-Johnson, and Amos Yong, \$30.00

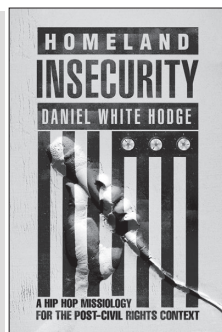

HOMELAND INSECURITY, Daniel White Hodge, \$27.00

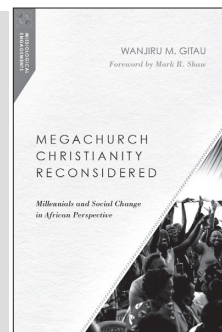

MEGACHURCH CHRISTIANITY RECONSIDERED, Wanjiru M. Gitau, \$30.00

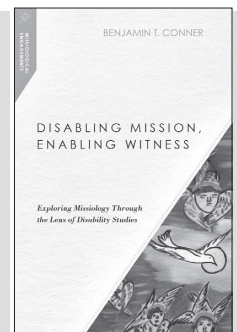

DISABLING MISSION, ENABLING WITNESS, Benjamin T. Conner, \$24.00

Free tote bag with purchase of \$25 or more, while supplies last.

IVPACADEMIC.COM

New from EERDMANS —

NEW BIBLICAL REFERENCE

NICNT

The Letter to the Galatians

David A. deSilva

9780802830555 / \$55

NICNT

The Letter to the Colossians

Scot McKnight

9780802867988 / \$55

PILLAR NEW TESTAMENT COMMENTARY

The Letters to Timothy and Titus

Robert W. Yarbrough

9780802837332 / \$55

TWO HORIZONS OLD TESTAMENT COMMENTARY

Habakkuk

Heath A. Thomas

9780802868701 / \$25

TWO HORIZONS OLD TESTAMENT COMMENTARY

Ezra and Nehemiah

David J. Shepherd and
Christopher J.H. Wright

9780802864321 / \$28

TWO HORIZONS NEW TESTAMENT COMMENTARY

Matthew

Jeannine K. Brown and Kyle A. Roberts

9780802825667 / \$38

THEOLOGICAL DICTIONARY OF THE OLD TESTAMENT

Volume XVI: Aramaic Dictionary

Holger Gzella, ed.

9780802872814 / \$75

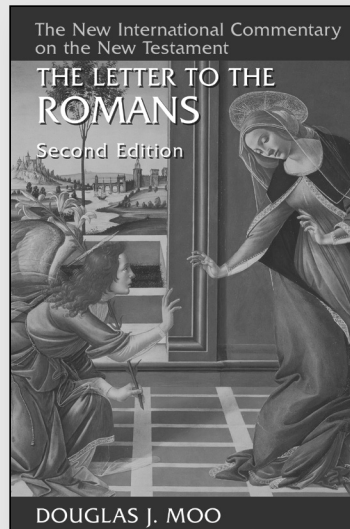

NICNT

The Letter to the Romans

Second Edition

Douglas J. Moo

9780802871213 / \$80

NEW BOOKS ON THIS YEAR'S THEME

This Incredibly Benevolent Force: The Holy Spirit in Reformed Theology and Spirituality

Cornelis van der Kooi

9780802876133 / \$38

Jesus the Spirit Baptizer: Christology in Light of Pentecost

Frank D. Macchia

9780802873897 / \$48

Powers, Principalities, and the Spirit: Biblical Realism in Africa and the West

Esther E. Acolatse

9780802864055 / \$32

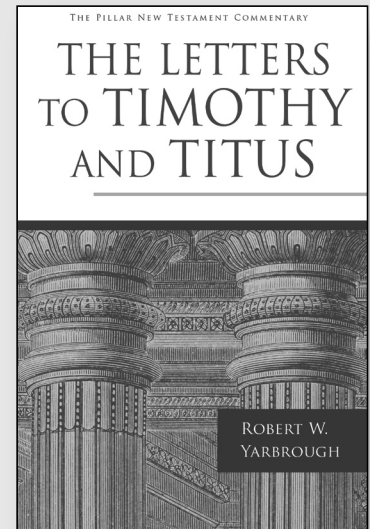

PILLAR NEW TESTAMENT COMMENTARY

The Letters to Timothy and Titus

Robert W. Yarbrough

9780802837332 / \$55

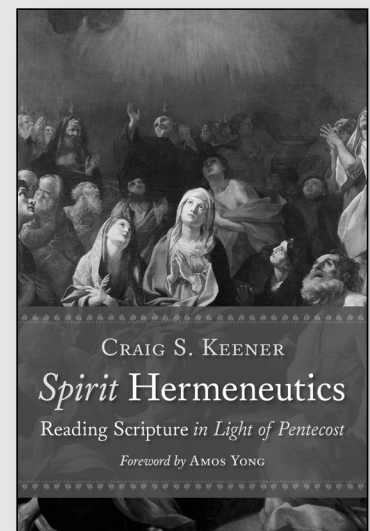

Spirit Hermeneutics: Reading Scripture in Light of Pentecost

Craig S. Keener

9780802875617 / \$40



Evangelical
Theological
Society Speaker



WM. B. EERDMANS
PUBLISHING CO.

Visit us at BOOTH #327 for
40% off every Eerdmans title!

www.eerdmans.com

Conference special 40% off!

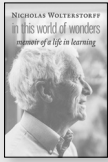

In This World of Wonders: Memoir of a Life of Learning
Nicholas Wolterstorff

9780802876799 / \$25

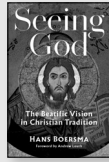

Seeing God: The Beatific Vision in Christian Tradition
Hans Boersma

9780802876041 / \$55

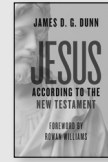

Jesus According to the New Testament
James D. G. Dunn

9780802876690 / \$20



Jesus in Jerusalem: The Last Days
Eckhard J. Schnabel

9780802875808 / \$60



Religion and American Culture: A Brief History
George M. Marsden

9780802875396 / \$30



A Life that is Good: The Message of Proverbs in a World Wanting Wisdom
Glenn Pemberton

9780802875679 / \$18



Believe Me: The Evangelical Road to Donald Trump
John Fea

9780802876416 / \$24.99

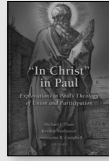

"In Christ" in Paul
Michael J. Thate, Kevin J. Vanhoozer, and Constantine R. Campbell, eds.

9780802873941 / \$55

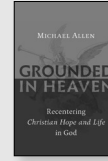

Grounded in Heaven: Reconnecting Christian Hope and Life in God
Michael Allen

9780802874535 / \$18

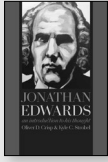

Jonathan Edwards: An Introduction to His Thought
Oliver D. Crisp and Kyle C. Strobel

9780802872692 / \$28

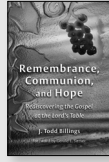

Remembrance, Communion, and Hope
J. Todd Billings

9780802862334 / \$25



The Violence of the Biblical God: Canonical Narrative and Christian Faith
L. Daniel Hawk

9780802872449 / \$35



Early Jewish Literature: An Anthology
Brad Embry, Ronald Herms, and Archie T. Wright, eds.

9780802866691 / \$125



Biblical Hebrew: An Introductory Grammar, Second Edition
Page H. Kelley and Timothy G. Crawford

9780802874917 / \$40

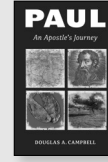

Paul: An Apostle's Journey
Douglas A. Campbell

9780802873477 / \$22

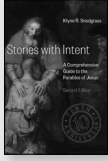

Stories with Intent: A Comprehensive Guide to the Parables of Jesus, Second Edition
Klyne R. Snodgrass

9780802875693 / \$58

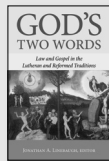

God's Two Words: Law and Gospel in the Lutheran and Reformed Traditions
Jonathan A. Linebaugh

9780802874757 / \$35



Incarnational Mission: Being with the World
Samuel Wells

9780802874863 / \$22



Introducing the Old Testament
Robert L. Hubbard and J. Andrew Dearman

9780802867902 / \$40

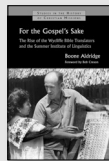

For the Gospel's Sake
Boone Aldridge

9780802876102 / \$45



Preaching Adverbially
F. Russell Mitman

9780802875587 / \$30



Advent: The Once and Future Coming of Jesus Christ
Fleming Rutledge

9780802876195 / \$30



Cultivating Teen Faith: Insights from the Confirmation Project
Richard R. Osmer and Katherine M. Douglass, eds.

9780802876607 / \$22



An Introduction to the Scriptures of Israel
Tzvi Novick

9780802875426 / \$25

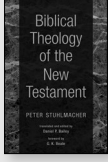

Biblical Theology of the New Testament
Peter Stuhlmacher

9780802840806 / \$95

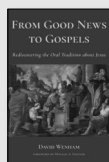

From Good News to Gospels: What Did the First Christians Say about Jesus?
David Wenham

9780802873682 / \$16

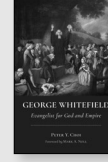

George Whitefield: Evangelist for God and Empire
Peter Y. Choi

9780802875495 / \$24



A Documentary History of Religion in America, Fourth Edition
Edwin S. Gaustad, Mark A. Noll, and Heath W. Carter, eds.

9780802873583 / \$60



Christian Hospitality and Muslim Immigration in an Age of Fear
Matthew Kaemingk

9780802874580 / \$28

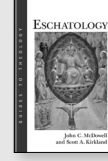

Eschatology
John C. McDowell and Scott A. Kirkland

9780802864581 / \$24

The
GREEK
NEW TESTAMENT

PRODUCED AT TYNDALE HOUSE, CAMBRIDGE



The Greek New Testament, Produced at Tyndale House, Cambridge, edited by Dr. Dirk Jongkind and Dr. Peter Williams, is a critical Greek text reflecting decades of scholarly advances and groundbreaking scribal-habit studies.

“This text of the New Testament has been ten years in the making, and the expertise of the editorial team is apparent on every page.”

Geoffrey Horrocks, Professor Emeritus of Comparative Philology, University of Cambridge

<p>1:17 ΠΡΟΣ ΓΑΛΑΤΑΣ 4</p> <p>αὐτὸν ἐν τοῖς ἔθνεσιν, εὐθέως οὐ προαναβήμεν σαρκὶ καὶ ὄματι, Ἥ οὐδὲ ἀνήλθον εἰς Ἱερουσόλυμα πρὸς τοὺς πρό ἡμοῦ ἀποστόλους, ἀλλὰ ἀπήλθον εἰς Ἀραβίαν καὶ πάλιν ὑπέστρεψα εἰς Δαμασκόν. ¹⁸Ἐπειτα μετὰ ἑπτὰ τρία ἀνήλθον εἰς Ἱερουσόλυμα ἱστορήσα Κηρῶν καὶ ἐπέμνα πρὸς αὐτὸν ἡμέρας δεκαπέντε. ¹⁹Ἐτερον δὲ τῶν ἀποστόλων οὐκ εἶδον, εἰ μὴ Ἰάκωβον τὸν ἀδελφὸν τοῦ κυρίου. ²⁰Ἄ δὲ γράφο ἡμῖν, ἰδοὺ ἐνώπιον τοῦ θεοῦ ὅτι οὐ ψευδοῦμαι. ²¹Ἐπειτα ἦλθον εἰς τὰ κλίματα τῆς Συρίας καὶ τῆς Κιλικίας. ²²Ἦμῃν δὲ ἀγνοοῦμενος τῷ προσώπῳ ταῖς ἐκκλησίαις τῆς Ἰουδαίας ταῖς ἐν χριστῷ, ²³μόνον δὲ ἀκούοντες ἦσαν ὅτι ὁ δῶκον ἡμᾶς ποτε νῦν εὐαγγελίζεται τὴν πίστιν ἣν ποτε ἐπόρευθαι. ²⁴καὶ ἐδοξάζον ἐν ἐμοὶ τὸν θεόν.</p> <p>2 ²⁵Ἐπειτα δὲ δεκατεσσάρων ἐτῶν πάλιν ἀνέβην εἰς Ἱερουσόλυμα μετὰ Βαρνάβην συναρπαλαβὼν καὶ Τίτον. ²⁶ἀνέβην δὲ κατὰ ἀποκάλυψιν καὶ ἀνεβήμεν αὐτοῖς τὸ εὐαγγέλιον ὃ κηρύσσω ἐν τοῖς ἔθνεσιν, κατ' ἰδίαν δὲ τοῖς δοκοῦσιν, μὴ πως εἰς κενὸν τρέχω ἢ ἔδραμον. ²⁷ἀλλ' οὐδὲ Τίτος ὁ σὺν ἐμοί, Ἐλὴν ὢν, ἠναγκάσθη περιτμηθῆναι. ²⁸ἀπὸ δὲ τοῦ παρεσάκτους ψευδαδελφούς, οἵτινες παρεστήλθον κατασκοπήσαι τὴν ἐλευθερίαν ἡμῶν ἣν ἔχομεν ἐν χριστῷ Ἰησοῦ, ἵνα ἡμᾶς καταδουλώσουσιν. ²⁹οἷς οὐδὲ πρὸς ὄραν εἰκαμεν τῆ ὑποταγῆ, ἵνα ἡ ἀλήθεια τοῦ εὐαγγελίου διαμείνῃ πρὸς ὑμᾶς. ³⁰ἀπὸ δὲ τῶν δοκούντων εἶναι τι, ὅποιοι ποτε ἦσαν, οὐδὲν μοι διαφέρει. πρόσπονον θεὸς ἀνθρώπου οὐ λαμβάνει· ἐμοὶ γὰρ οἱ δοκοῦντες οὐδὲν προαναβένοντο, ³¹ἀλλὰ τούναντιον, ἰδόντες ὅτι πεπιστευμαι τὸ εὐαγγέλιον τῆς ἀκροβυστίας καθὼς Πέτρος τῆς περιτομῆς. ³²ὅ γὰρ ἐνεργῆσεν Πέτρος εἰς ἀποστολὴν τῆς περιτομῆς ἐνήργησεν κἀμοὶ εἰς τὰ ἔθνη. ³³καὶ γινόντες τὴν χάριν τὴν δοθεῖσάν μοι, Ἰάκωβος καὶ Κηρῶν καὶ Ἰωάννης, οἱ δοκοῦντες στίλοι εἶναι, δεξιάς ἔδωκαν ἐμοὶ καὶ Βαρνάβην κοινωνίας, ἵνα εἰς ἡμᾶς τὰ ἔθνη, αὐτοὶ δὲ εἰς τὴν περιτομὴν, ³⁴μόνον τῶν πτωχῶν ἵνα μνημονεύομεν ὃ καὶ ἐποίησαν αὐτὰ τοῦτο ποιῆσαι.</p> <p>³⁵ὅτε δὲ ἦλθεν Κηρῶν εἰς Ἀντιόχειαν, κατὰ πρόσωπον αὐτῷ ντέστην, ὅτι κατηγορούμενος ἦν. ³⁶πρὸ τοῦ γὰρ ἔλθειν τινας ἀπὸ Ἰακώβου μετὰ τῶν ἐθνῶν συνήσθηεν ὅτε δὲ ἦλθον, ὑπέστειλεν καὶ φώριζεν</p>	<p>5 ΠΡΟΣ ΓΑΛΑΤΑΣ 3:11</p> <p>ἐαυτὸν φοβούμενος τοὺς ἐκ περιτομῆς. ¹²καὶ συνεπεκρίθησαν αὐτῷ καὶ οἱ λοιποὶ Ἰουδαῖοι ὥστε καὶ Βαρνάβην συναπήγη αὐτῶν τῆ ὑποκρίσει. ¹³ἀλλ' ὅτε εἶδον ὅτι οὐκ ἀρθροδοοῦσιν πρὸς τὴν ἀλήθειαν τοῦ εὐαγγελίου, εἶπον τῷ Κηρῷ ἐμπροσθεν πάντων· εἰ σὺ Ἰουδαῖος ὑπάρχων ἐθνικός καὶ οὐκ Ἰουδαϊκῶς ζῆς, πὼς τὰ ἔθνη ἀναγκάζεις Ἰουδαῖζεν; ¹⁴ἡμεῖς φροεῖ Ἰουδαῖοι καὶ οὐκ ἐξ ἐθνῶν ἀμαρτωλοὶ. ¹⁵εἰδότες δὲ ὅτι οὐ δικαιοῦται ἄνθρωπος ἐξ ἔργων νόμου ἐὰν μὴ διὰ πίστεως Ἰησοῦ χριστοῦ, καὶ ἡμεῖς εἰς χριστὸν Ἰησοῦν ἐπιστεῖσαμεν, ἵνα δικαιοῦθωμεν ἐκ πίστεως χριστοῦ καὶ οὐκ ἐξ ἔργων νόμου· ὅτι ¹⁶εἰ δὲ ἤτοίντες δικαιοῦθημεν ἐν χριστῷ εὐρέθημεν καὶ αὐτοὶ ἀμαρτωλοὶ, ἀρα χριστὸς ἀμαρτίας δάκονος; μὴ γένοιο. ¹⁷εἰ γὰρ ἂ κατέλυσα, ταῦτα πάλιν οἰκοδομῶ, παραβάτην ἐμαυτὸν συνιστάνω. ¹⁸ἐγὼ γὰρ διὰ νόμου νόμῳ ἀπέθανον, ἵνα θεῷ ἴησω. χριστῷ συνεσταύρωμαι. ¹⁹ὡς δὲ οὐκέτι ἐγὼ, ἦ ἢ δὲ ἐν ἐμοὶ χριστός· ὃ δὲ νῦν ζῶ ἐν σαρκί, ἐν πίστει ζῶ τῆ τοῦ θεοῦ τοῦ ἀγαπήσαντός με καὶ παραδόντος ἐαυτὸν ὑπὲρ ἐμοῦ. ²⁰δοιο ἀθετο τὴν χάριν τοῦ θεοῦ· εἰ γὰρ διὰ νόμου δικαιοσύνη, ἀρα χριστὸς δωρεὰν ἀπέθανεν.</p> <p>3 ²¹Ὡ ἀνόητοι Γαλιᾶται, τίς ὑμᾶς ἐβάσκανεν, οἱς προεγράφη ²²τοιοτό μόνον θέλω μαθεῖν ἀπ' ὑμῶν· ἐξ ἔργων νόμου τὸ πνεῦμα ἐλάβετε ἢ ἐξ ἀκοῆς πίστεως; ²³οὗτος ἀνόητος ἔστε; ἐναρξάμενοι πνεύματι νῦν σαρκὶ ἐπιτελείσθε; ²⁴τοσοῦτα ἐπάθετε εἰσθ; εἰ γε καὶ εἰσθ.</p> <p>²⁵Ὁ οὖν ἐπιχορηγῶν ὑμῖν τὸ πνεῦμα καὶ ἐνεργῶν δυνάμεις ἐν ὑμῖν, ἐξ ἔργων νόμου ἢ ἐξ ἀκοῆς πίστεως; ²⁶καθὼς Ἀβραὰμ ἐπίστευσεν τῷ θεῷ καὶ ἐλογίσθη αὐτῷ εἰς δικαιοσύνην. ²⁷γινώσκετε ἀρα ὅτι οἱ ἐκ πίστεως οὗτοι εἰσι υἱοὶ Ἀβραάμ. ²⁸προδοῖσα δὲ ἡ γραφὴ ὅτι ἐκ πίστεως δικαιοὶ τὰ ἔθνη ὁ θεός, προεγγηγάτο τῷ Ἀβραάμ ὅτι ἐνευλογηθήσονται ἐν σοὶ πάντα τὰ ἔθνη. ²⁹ὥστε οἱ ἐκ πίστεως εὐλογοῦνται σὺν τῷ πιστῷ Ἀβραάμ. ³⁰δοιο γὰρ ἐξ ἔργων νόμου εἰσιν, ὑπὸ κατάραν εἰσιν· γέγραπται γὰρ ὅτι ἐπικατάρατος πᾶς ὃς οὐκ ἐμμένει ἐν πίστει γεγραμμένος ἐν τῷ βιβλίῳ τοῦ νόμου τοῦ ποιῆσαι αὐτά. ³¹ὅτι δὲ ἐν νόμῳ οὐδεὶς δικαιοῦται</p> <p><small>^{2:18} Ἰησοῦ χριστοῦ χριστοῦ ἰησοῦ A B 33; txt P46 M C D F G H K L P Ψ Byz. et al. χριστοῦ Ἰησοῦ ἰησοῦ ἰησοῦ P46 B H 33 1175 1241 1505 1739 1881; txt N A C D F G K L P Ψ Byz. et al. ^{2:19} διον C D2 H K L P Ψ Byz; txt P46 R A B D F G I 6 33 81 104 365 1175 1241 1505 1881 2464. ^{2:20} πὼς οὐκ ἐθνοδοῦσιν πρὸς τὸν θεόν καὶ χριστῷ P46 B D F G; txt N A C D F G H K L P Ψ Byz. et al. ^{2:21} ἐμαυτὸν καὶ τὴν ἀλήθειαν μὴ συνθεῖσθαι C D2 K L P Ψ 0278 33c Byz. et al.; txt N A B D F G 33* 81 630 1739 7 ^{2:22} ἰσιν υἱοὶ υἱοὶ εἰσιν P46 N B P Ψ 81 326 1241 2464; txt N2 A C D F G K 0278 Byz. et al. ^{2:23} ἐν πνεύματι ἐν P46 N B P Ψ 0278 6 33 81 104 365 630 1175 1241 1739 1881 2464; enit novum 1505; txt N2 A C D F G K L P Byz.</small></p>
--	---

COVER OPTIONS

Hardcover, 978-1-4335-5217-5, ~~\$39.99~~ \$15
TruTone, Black, 978-1-4335-5856-6, ~~\$69.99~~ \$35

The
GREEK
NEW TESTAMENT

PRODUCED AT TYNDALE HOUSE, CAMBRIDGE



READER'S EDITION

This new reader's edition of the Greek New Testament text combines *The Greek New Testament, Produced at Tyndale House, Cambridge* with a running list of glosses of every word in the Greek New Testament that occurs 25 times or less. Those with limited knowledge of Greek can smoothly read the Greek text without needing to constantly refer to other reference resources—accelerating their facility with the Greek text and making their time more rewarding and more enjoyable as they read the very Word of God.

COVER OPTIONS

Hardcover, 978-1-4335-6415-4, ~~\$39.99~~ \$15
TruTone, Black, 978-1-4335-6519-9, ~~\$69.99~~ \$35

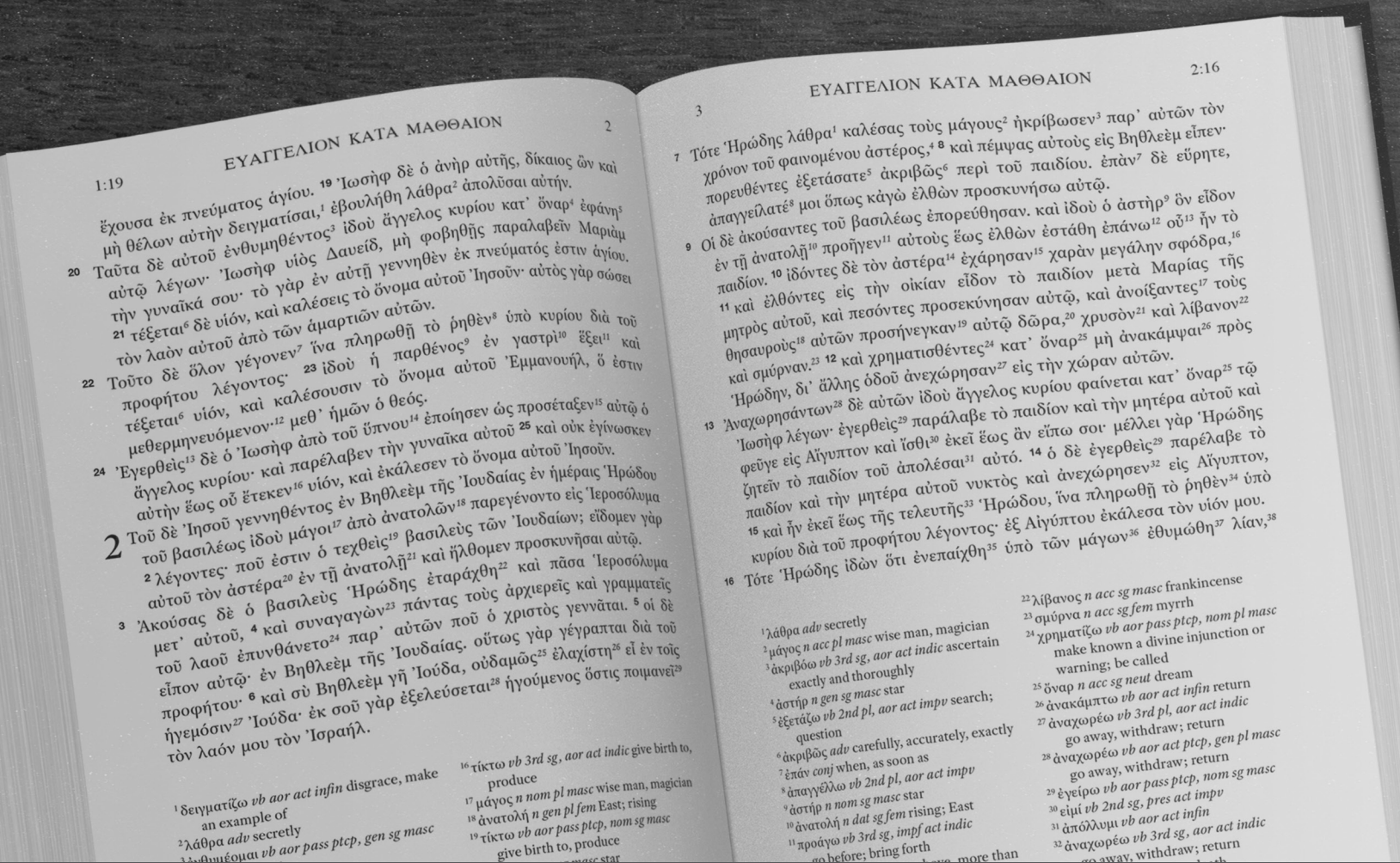

NEW FROM CROSSWAY

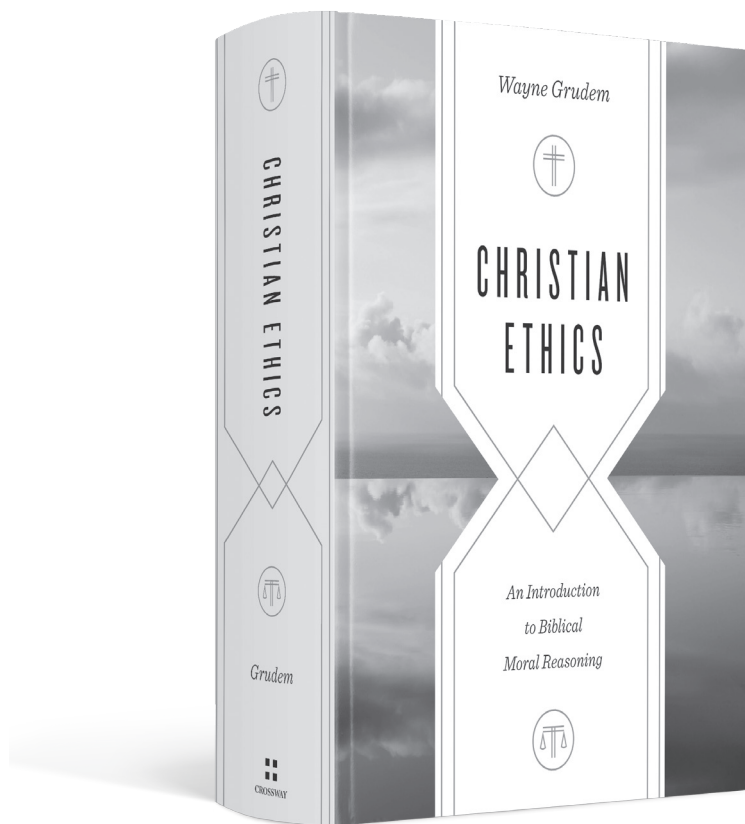

What does the Bible teach about how to live in today's world?

Best-selling author and professor Wayne Grudem distills over forty years of teaching experience into a single volume aimed at helping readers apply a biblical worldview to difficult ethical issues, including wealth and poverty, marriage and divorce, birth control, abortion, euthanasia, homosexuality, business practices, environmental stewardship, telling the truth, knowing God's will, understanding Old Testament laws, and more.

Christian Ethics: An Introduction to Biblical Moral Reasoning

Wayne Grudem

Hardcover, 978-1-4335-4965-6
1,296 pages | ~~\$59.99~~ \$30

EXPLORE THE ANCIENT WORLD BEHIND THE LIVING WORD

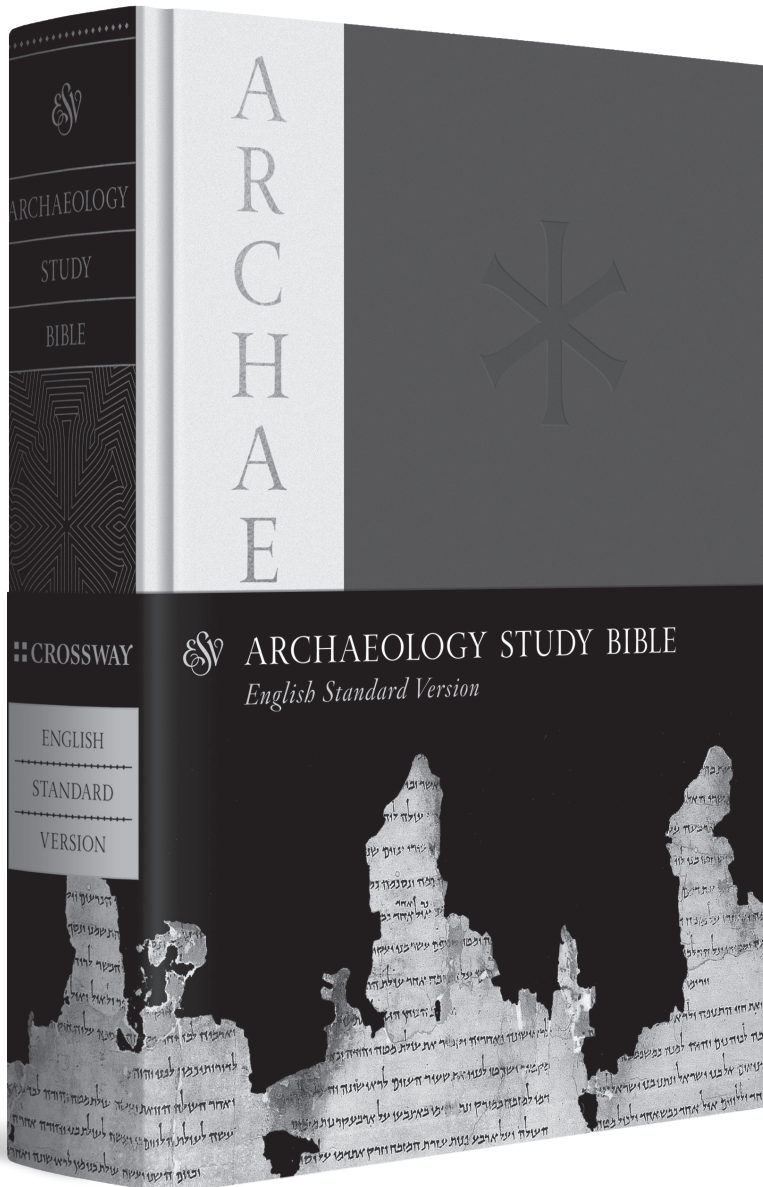

The *ESV Archaeology Study Bible* roots the biblical text in its historical and cultural context, giving Bible readers a framework for better understanding the people, places, and events recorded in Scripture.

- 2000+ study notes
- 400+ full-color photographs
- 15 articles
- 200+ maps and diagrams
- 4 timelines
- Chart of ancient texts

“This marvelous resource will help readers visualize the people and places of the Bible and appreciate the importance of archaeology for a deeper and more accurate understanding of Scripture.”

CRAIG A. EVANS, John Bisagno Distinguished Professor of Christian Origins, Houston Baptist University

COVER OPTIONS

Hardcover, 978-1-4335-5040-9, ~~\$49.99~~ \$25 (shown)

TruTone, Brown, 978-1-4335-5041-6, ~~\$79.99~~ \$32.50

Genuine Leather, Black, 978-1-4335-5042-3, ~~\$99.99~~ \$50

NEW FROM CROSSWAY

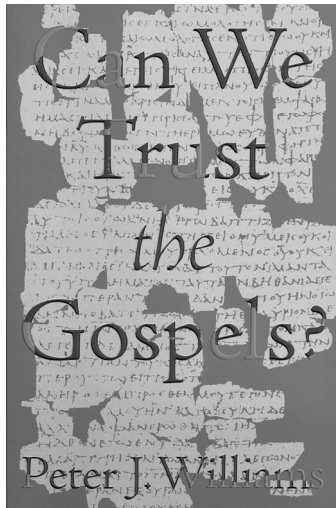

Can We Trust the Gospels?

Peter J. Williams

Paperback, 978-1-4335-5295-3
160 pages | ~~\$14.99~~ \$7.50

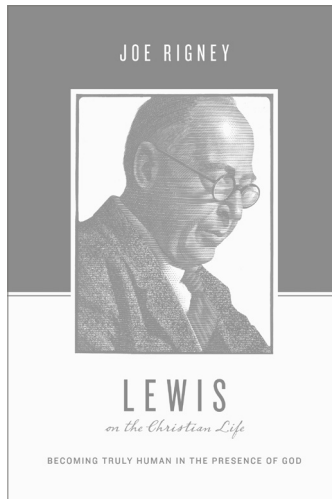

Lewis on the Christian Life

Joe Rigney

Paperback, 978-1-4335-5055-3
320 pages | ~~\$21.99~~ \$11

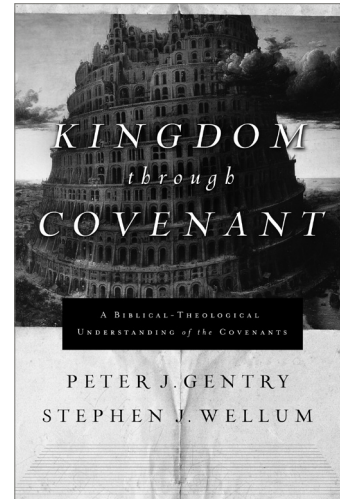

Kingdom through Covenant (Second Edition)

Peter J. Gentry and
Stephen J. Wellum

Hardcover, 978-1-4335-5307-3
960 pages | ~~\$55~~ \$27.50

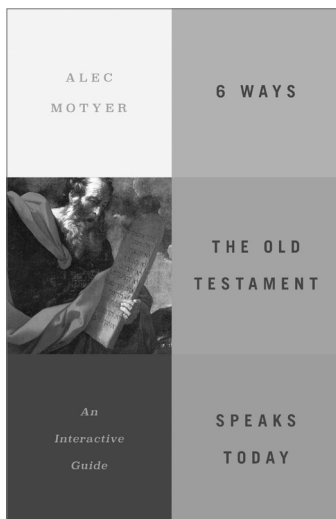

6 Ways the Old Testament Speaks Today

Alec Motyer

Paperback, 978-1-4335-5851-1
240 pages | ~~\$19.99~~ \$10

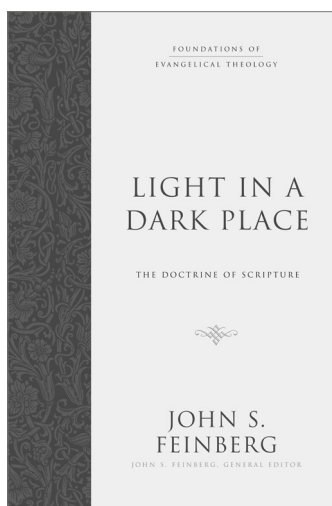

Light in a Dark Place

John S. Feinberg

Hardcover, 978-1-4335-3927-5
800 pages | ~~\$50.00~~ \$25

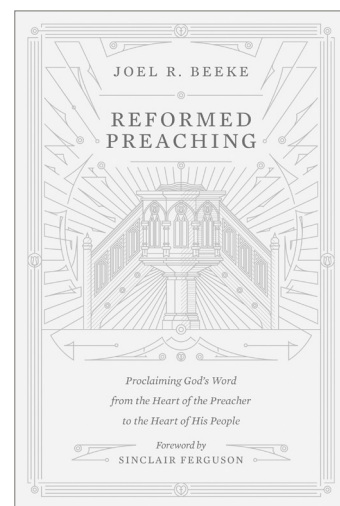

Reformed Preaching

Joel R. Beeke

Hardcover, 978-1-4335-5927-3
512 pages | ~~\$40~~ \$20

NEW FROM CROSSWAY

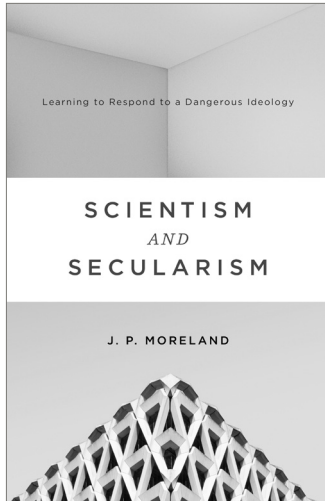

Scientism and Secularism

J. P. Moreland

Paperback, 978-1-4335-5690-6
224 pages | ~~\$16.99~~ \$8.50

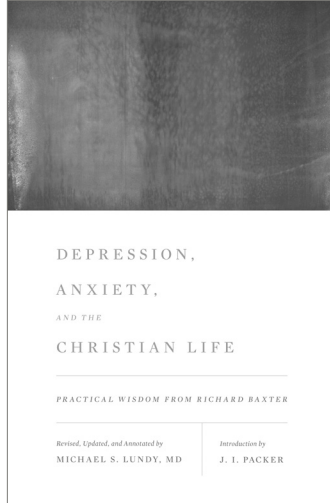

Depression, Anxiety, and the Christian Life

Revised, Updated, and Annotated
by Michael S. Lundy, MD;
Introduction by J. I. Packer

Paperback, 978-1-4335-4206-0
192 pages | ~~\$14.99~~ \$7.50

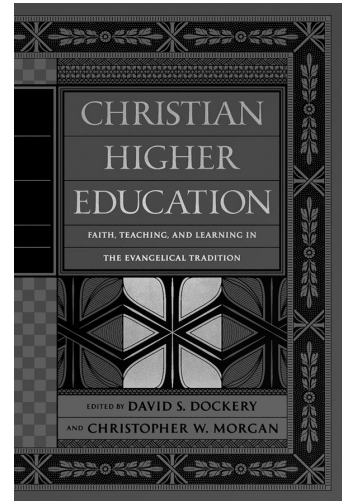

Christian Higher Education

David S. Dockery and
Christopher W. Morgan, eds.

Hardcover, 978-1-4335-5653-1
576 pages | ~~\$50~~ \$25.00

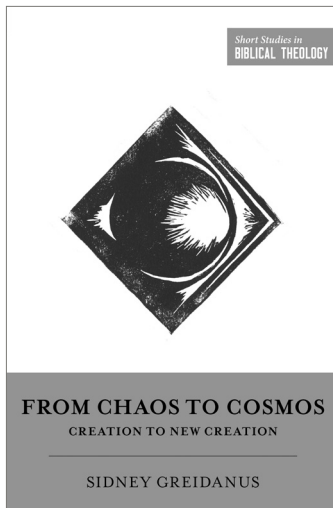

From Chaos to Cosmos: Creation to New Creation

Sidney Greidanus

Paperback, 978-1-4335-5497-1
144 pages | ~~\$14.99~~ \$7.50

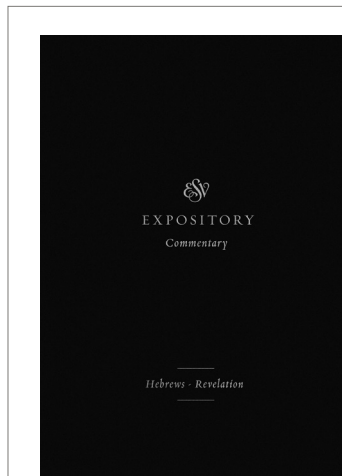

ESV Expository Commentary

Iain M. Duguid, James M. Hamilton Jr.,
and Jay Sklar, series eds.

Designed to strengthen the global church with a widely accessible, theologically sound, and pastorally wise resource for understanding and applying the overarching storyline of the Bible, this commentary series features the full text of the ESV Bible passage by passage, with crisp and theologically rich exposition and application from a team of experienced pastor-theologians.

Current Volumes:

Daniel-Malachi
978-1-4335-4652-5
800 pages | ~~\$50~~ \$25

Ephesians-Philemon
978-1-4335-4668-6
576 pages | ~~\$40~~ \$25

Hebrews-Revelation
978-1-4335-4672-3
784 pages | ~~\$45~~ \$25

*Come visit us
in Booth 113
to learn more!*

Looking for an Excellent Graduate School?

Have You Considered Concordia Seminary, St. Louis?

Concordia Seminary's Graduate School prepares scholars for the highest level of theological excellence.

We offer:

- Rigorous theological scholarship
- World-renowned faculty
- Faithfulness to the Scriptures

Degrees:

- Master of Arts
- Master of Sacred Theology
- Doctor of Philosophy

To learn more about our programs visit www.csl.edu/programs

Apply today! Visit www.csl.edu/applygradschool



**Concordia
Seminary**
ST. LOUIS

801 Seminary Place, St. Louis, MO 63105
314-505-7000 | www.csl.edu



**MINISTRY ISN'T
JUST A CALLING ...
IT'S A WAY OF LIFE.**

Colorado Christian University offers degrees and programs in biblical studies and theology to match your academic interests and prepare you for a lifetime of ministry.

DEGREES AND PROGRAMS

Biblical Studies* [M.A., B.A., minor]
Intercultural Ministry [minor]
Ministry Management [B.A.]
Theology* [M.A., B.A., minor]
Young Life Leadership [minor]
Youth Ministry [B.A., minor]

* Dual degree options also available



**COLORADO CHRISTIAN
UNIVERSITY**

Grace and Truth

Visit us online at ccu.edu
or call 303.963.3000



BIBLEJOURNEY

“No one has studied the Bible like this before...”

*Dr. Timothy S. Laniak, BibleJourney Guide
Professor of Biblical Studies, Gordon-Conwell Seminary*

A Global 21st Century curriculum designed
for your computer, tablet & smartphone



A curriculum for teachers who want more
and students who deserve more

MASTER BIBLICAL HISTORY AND GEOGRAPHY

- ▶ 1st comprehensive Bible survey app
- ▶ Designed for schools, ministries and churches
- ▶ Six course program Genesis-Revelation
- ▶ College and seminary credit available
- ▶ Built in LMS with engaging interface

- ▶ Collaborative & constructive andragogy
- ▶ Historically orthodox interpretation
- ▶ Discover the Bible's global impact
- ▶ Music playlists for all modules
- ▶ Sync all your electronic devices
- ▶ Global Church perspectives on interpretation
- ▶ Epic onsite, drone & 360 videos

FREE FOR TEACHERS
BIBLEJOURNEY.COM



Why Beeson?

Beeson Divinity School is unique in the field of theological education. With a world-class faculty, Beeson is confessional yet interdenominational, evangelical yet ecumenical, and committed to the historic, orthodox Christian faith. This rich core of our common commitments form the basis of our unity as a theological community centered in Jesus Christ. We also believe in and practice incarnational theological education for incarnational gospel ministry. As John writes, "The Word became flesh and dwelt among us" (John 1:14). If God the creator of the universe was willing and saw it fit to take on flesh, we see great reasons to live life together within a community of faith and learning. Read what students are saying about "why Beeson" at beesondivinity.com/go/ets.

Beeson Divinity School
beesondivinity.com/go/ets

   @BeesonDivinity | #WhyBeeson



Samford University
Beeson Divinity School

800 Lakeshore Drive | Birmingham, AL 35229
1-800-888-8266

NEW FROM

BAKER ACADEMIC & BRAZOS PRESS

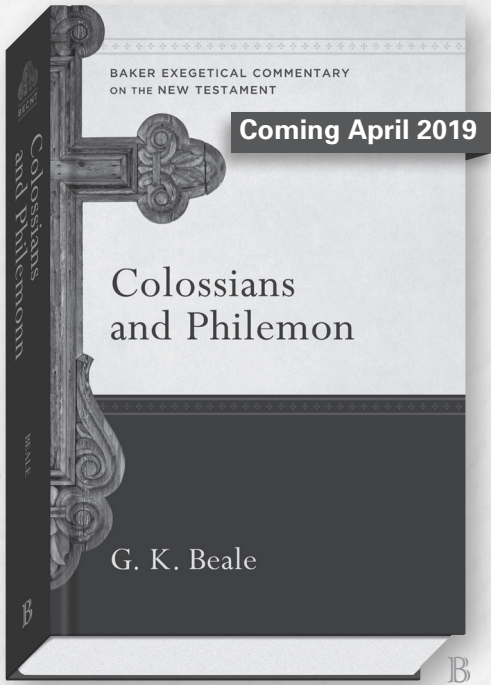

978-0-8010-2667-6 • 608 pp. • \$54.99c

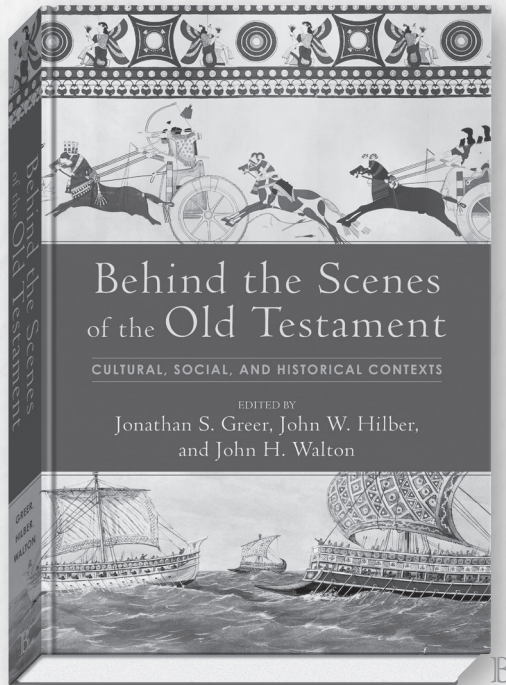

978-0-8010-9775-1 • 544 pp. • \$49.99c

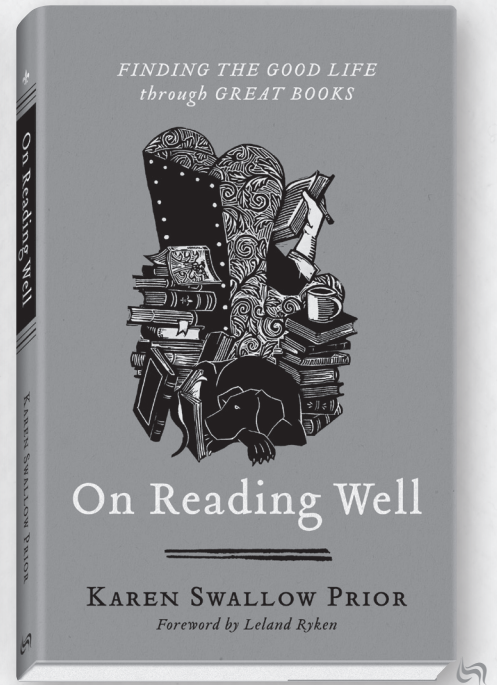

978-1-58743-396-2 • 272 pp. • \$19.99c

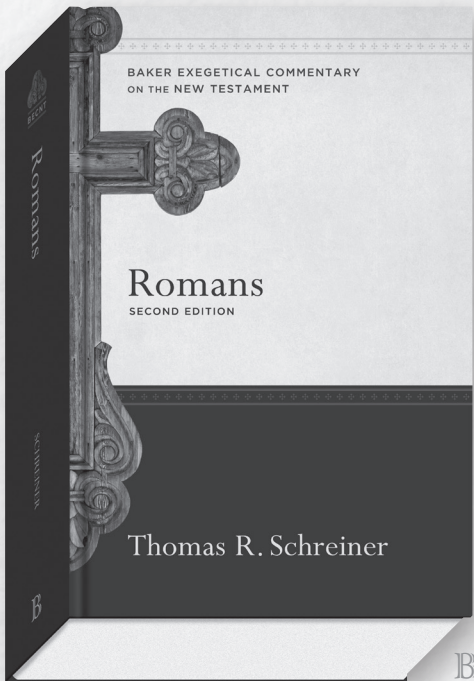

978-1-5409-6005-4 • 1,040 pp. • \$59.99c

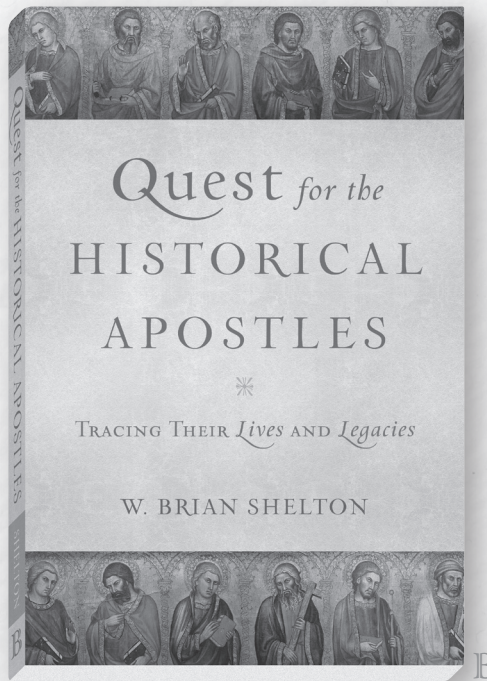

978-0-8010-9855-0 • 328 pp. • \$29.99p

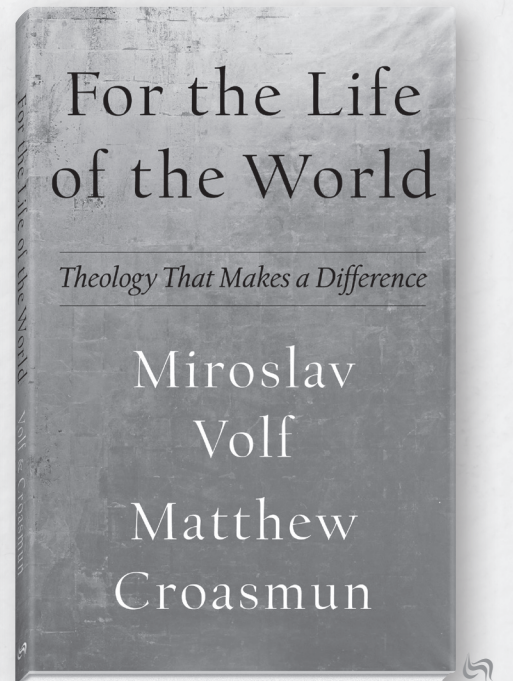

978-1-58743-401-3 • 208 pp. • \$21.99c

40% discount on all books. Visit booth #101.

NEW FROM

BAKER ACADEMIC & BRAZOS PRESS

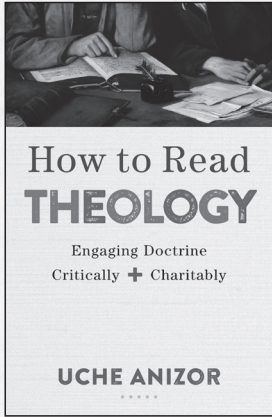

978-0-8010-4975-0 • 200 pp.
\$21.99p
B

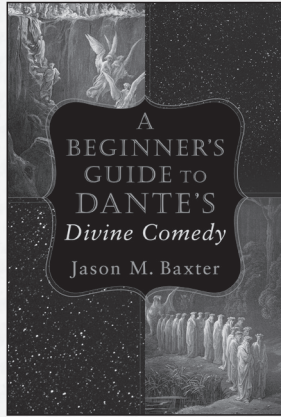

978-0-8010-9873-4 • 224 pp.
\$17.99p
B

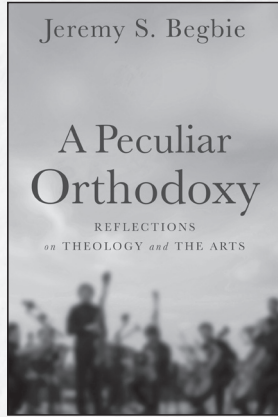

978-0-8010-9957-1 • 224 pp.
\$32.00c
B

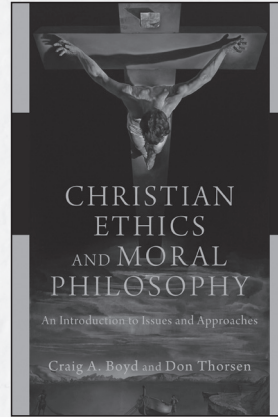

978-0-8010-4823-4 • 208 pp.
\$24.99p
B

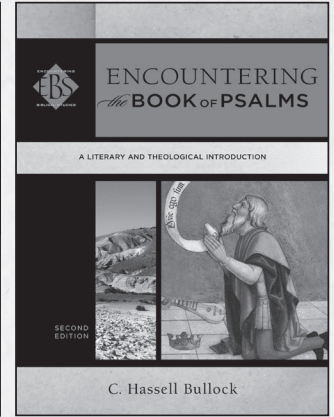

978-0-8010-9830-7 • 288 pp.
\$29.99p
B

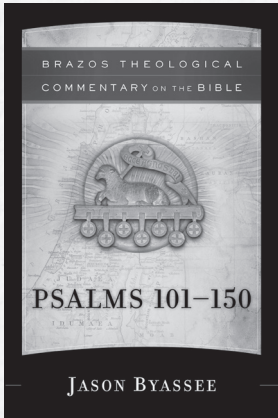

978-1-58743-352-8 • 288 pp.
\$32.99c
B

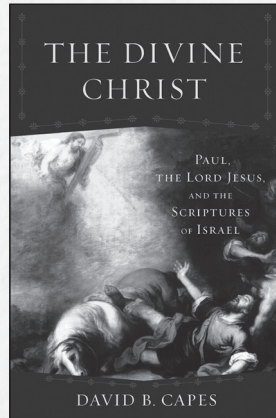

978-0-8010-9786-7 • 224 pp.
\$24.99p
B

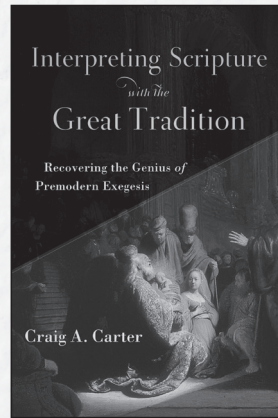

978-0-8010-9872-7 • 304 pp.
\$27.99p
B

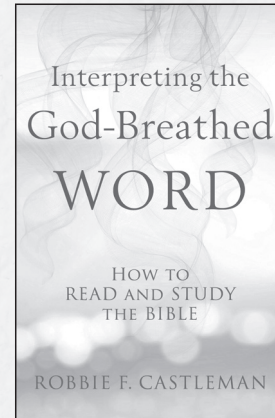

978-0-8010-9528-3 • 144 pp.
\$17.99p
B

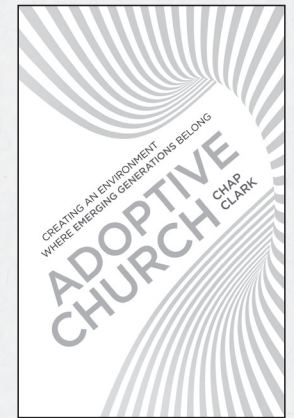

978-0-8010-9892-5 • 208 pp.
\$19.99p
B

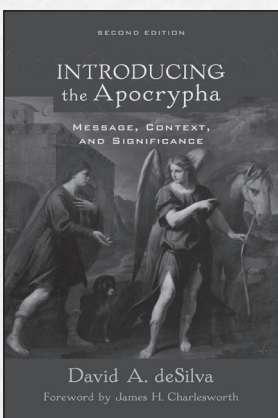

978-0-8010-9741-6 • 528 pp.
\$39.99p
B

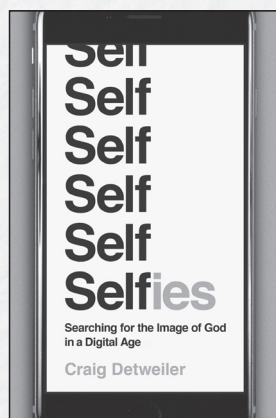

978-1-58743-398-6 • 240 pp.
\$19.99p
B

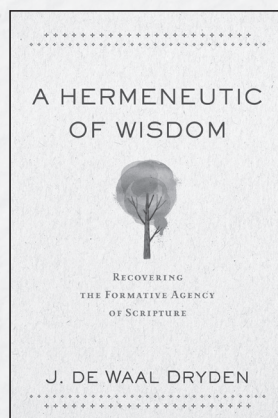

978-0-8010-9793-5 • 320 pp.
\$29.99p
B

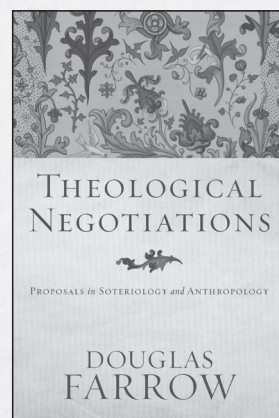

978-1-5409-6039-9 • 320 pp.
\$38.00c
B

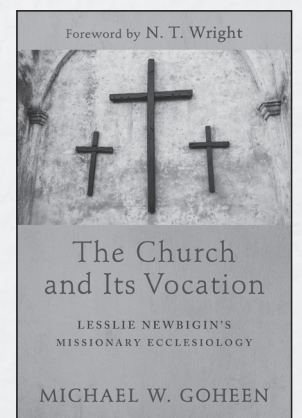

978-1-5409-6047-4 • 240 pp.
\$22.99p
B

40% discount on all books. Visit booth #101.

NEW FROM

BAKER ACADEMIC & BRAZOS PRESS

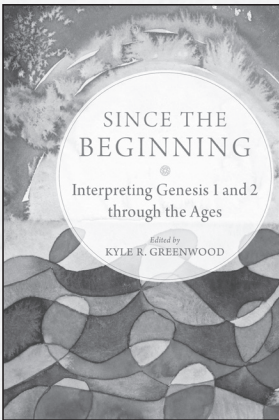

978-0-8010-3069-7 • 336 pp.
\$26.99p

B

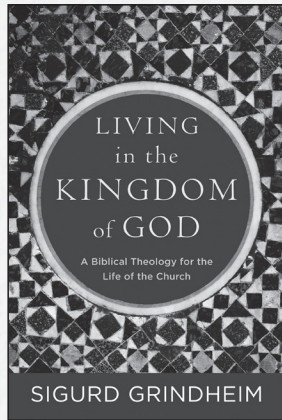

978-1-5409-6032-0 • 208 pp.
\$24.99p

B

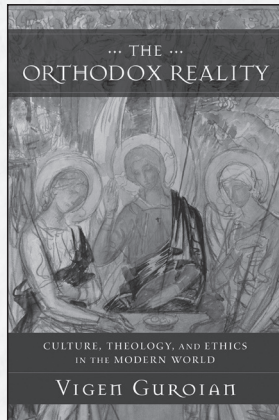

978-0-8010-9934-2 • 240 pp.
\$35.00c

B

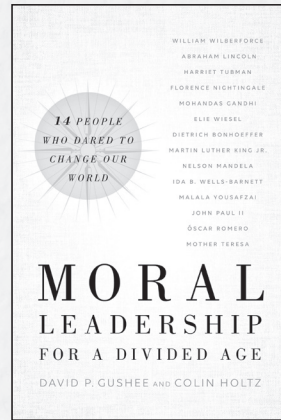

978-1-5874-3357-3 • 384 pp.
\$24.99c

↻

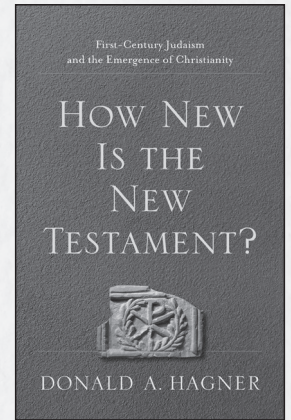

978-1-5409-6041-2 • 208 pp.
\$22.99p

B

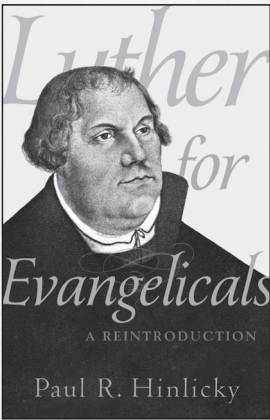

978-0-8010-9888-8 • 208 pp.
\$22.99p

B

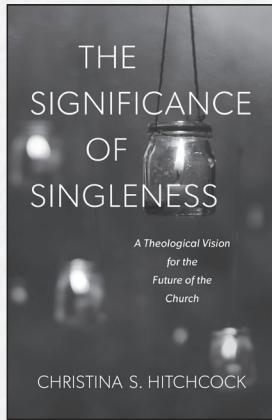

978-1-5409-6029-0 • 176 pp.
\$21.99p

B

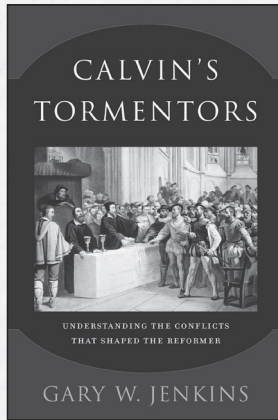

978-0-8010-9833-8 • 208 pp.
\$27.99p

B

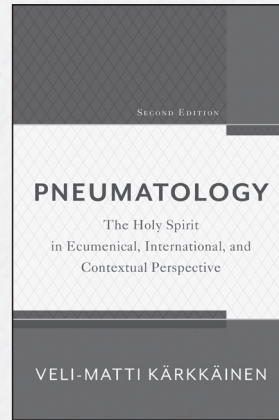

978-0-8010-9946-5 • 208 pp.
\$26.00p

B

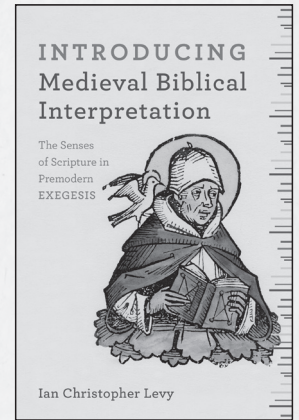

978-0-8010-4880-7 • 320 pp.
\$29.99p

B

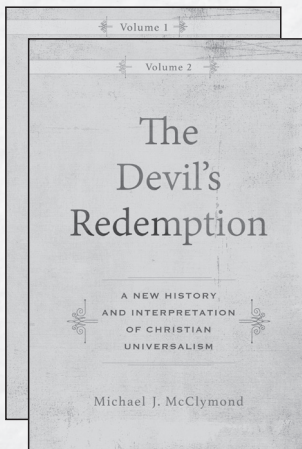

978-0-8010-4856-2 • 1,376 pp.
\$90.00c

B

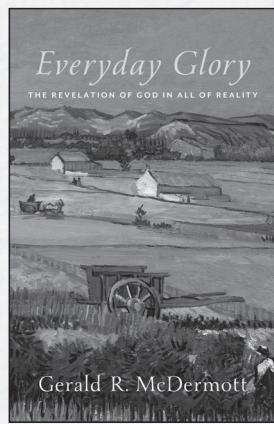

978-0-8010-9829-1 • 224 pp.
\$22.99p

B

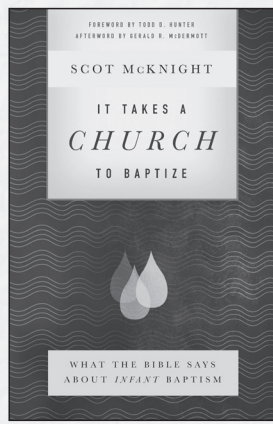

978-1-58743-416-7 • 144 pp.
\$16.99p

↻

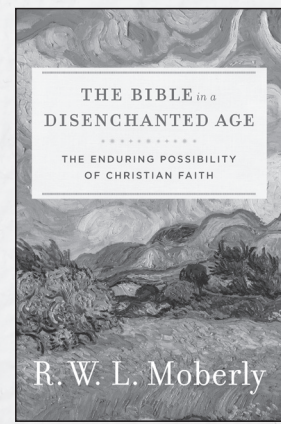

978-0-8010-9951-9 • 240 pp.
\$24.99c

B

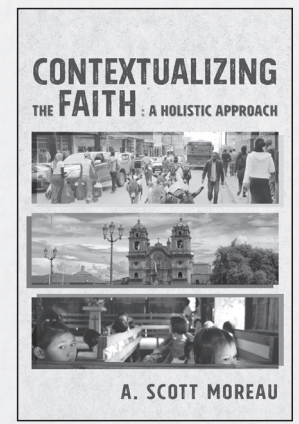

978-1-5409-6000-9 • 272 pp.
\$26.99p

B

40% discount on all books. Visit booth #101.

NEW FROM

BAKER ACADEMIC & BRAZOS PRESS

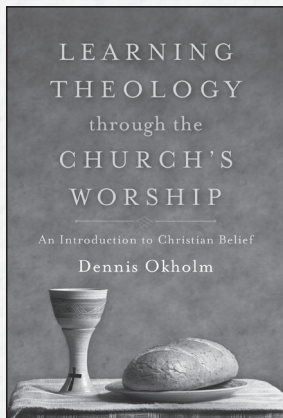

978-1-5409-6001-6 • 256 pp.
\$24.99p

B

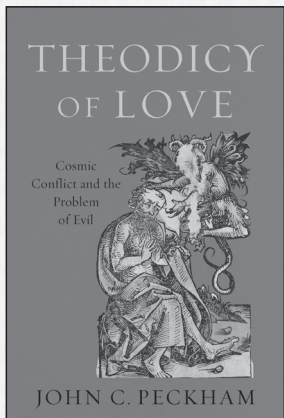

978-1-5409-6026-9 • 224 pp.
\$26.99p

B

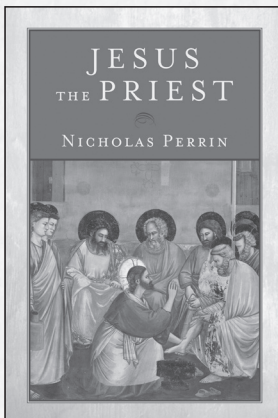

978-0-8010-4859-3 • 288 pp.
\$29.99p

B

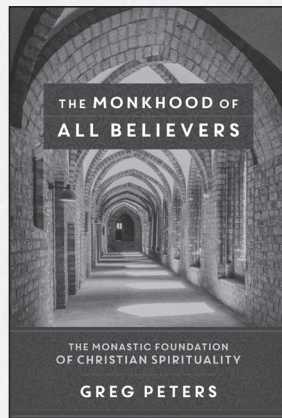

978-0-8010-9805-5 • 240 pp.
\$24.99p

B

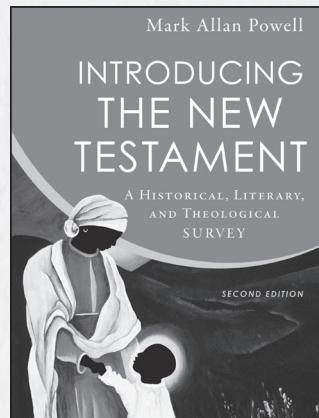

978-0-8010-9960-1 • 592 pp.
\$49.99c

B

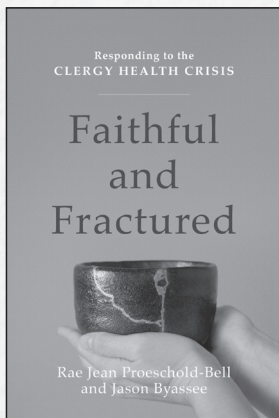

978-0-8010-9883-3 • 224 pp.
\$19.99p

B

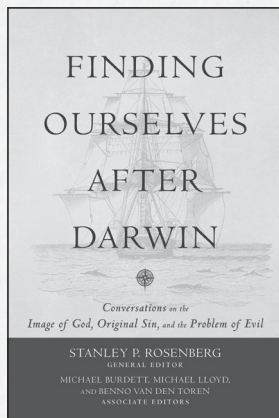

978-0-8010-9824-6 • 384 pp.
\$29.99p

B

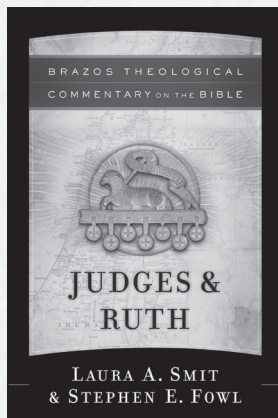

978-1-58743-330-6 • 288 pp.
\$32.99c

W

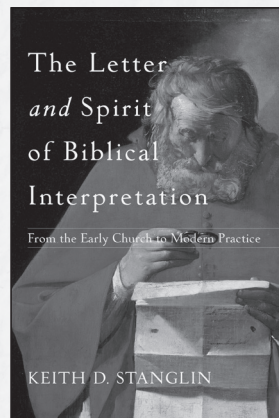

978-0-8010-4968-2 • 288 pp.
\$26.99p

B

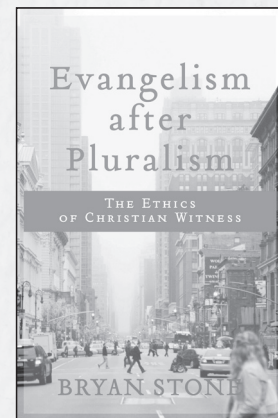

978-0-8010-9979-3 • 160 pp.
\$21.99p

B

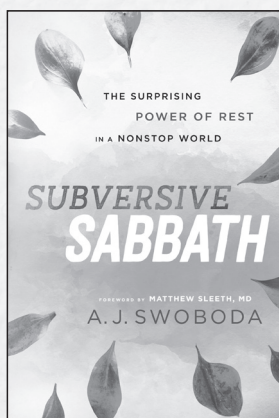

978-1-58743-405-1 • 256 pp.
\$19.99p

W

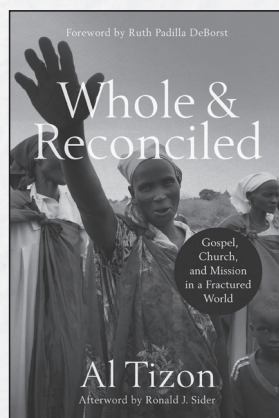

978-0-8010-9562-7 • 256 pp.
\$22.99p

B

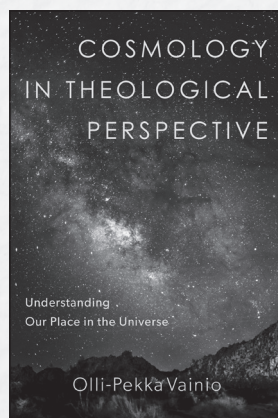

978-0-8010-9943-4 • 224 pp.
\$24.99p

B

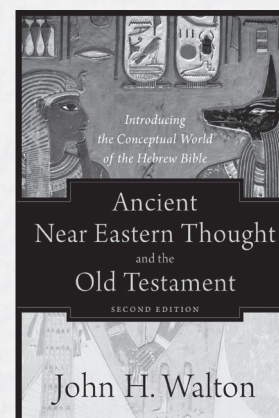

978-0-8010-9943-4 • 224 pp.
\$24.99p

B

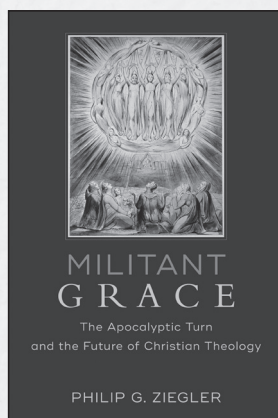

978-0-8010-9853-6 • 256 pp.
\$24.99p

B

40% discount on all books. Visit booth #101.

from BAYLOR UNIVERSITY PRESS

CRAIG L. BLOMBERG

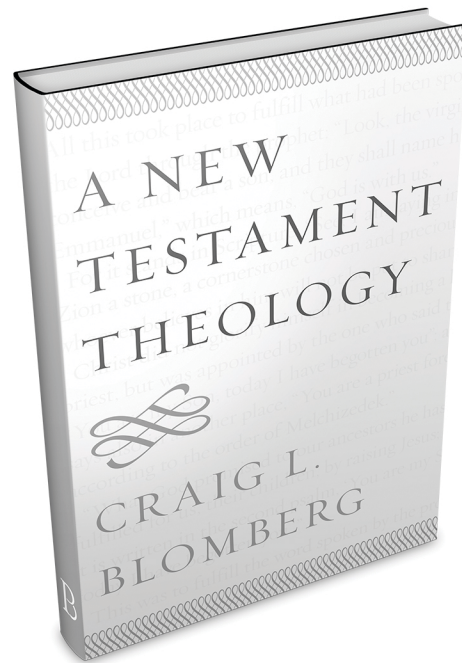

THE AGES HAVE TURNED,
GOD'S VICTORY IS ASSURED,
THERE IS STILL MUCH WORK TO BE DONE

A New Testament Theology

~~\$49.95~~ \$34.97 | 736 pages | 6 x 9 | Paper | 978-1-4813-0226-5 | October 1, 2018
~~\$79.95~~ \$55.97 | Printed Case | 978-1-4813-0227-2

Books for Good | baylorpress.com

Receive 30% off and free shipping on all BUP titles with discount code 17ETS until 12/31/18

INTRODUCING

WORLDVIEW
STUDY BIBLE

Over 100 Christian scholars provide invaluable tools and resources to better understand the grand narrative of Scripture. Includes 130 articles and nearly 6,000 study notes exploring the biblical framework from which we are called to make sense of life and the world.

General Editors: David S. Dockery and Trevin K. Wax



CHRISTIAN
STANDARD
BIBLE

HOLMAN[®]
BIBLES



NEW FROM B&H ACADEMIC

50% DISCOUNT ON ALL TITLES

Islam and North America

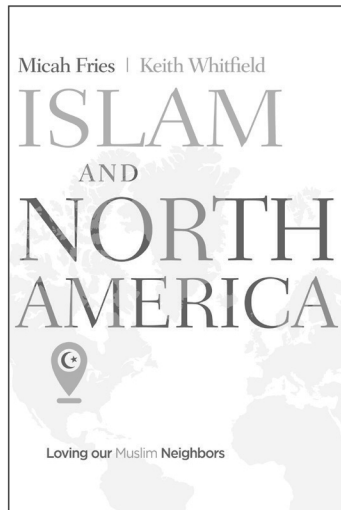

\$19.99

Stand Firm

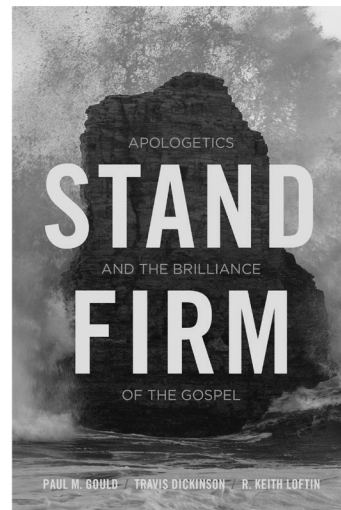

\$24.99

Spiritual Formation Is...

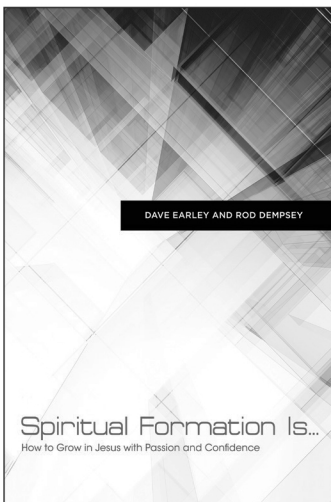

\$24.99

The God Who Goes Before You

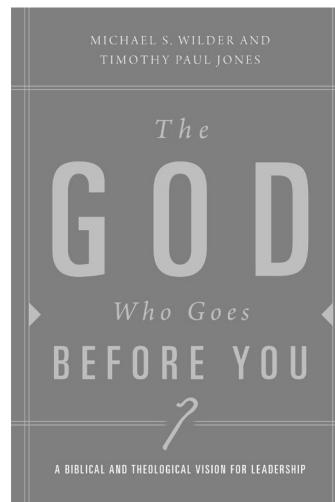

\$29.99

The Lost Sermons of C.H. Spurgeon Vol 3

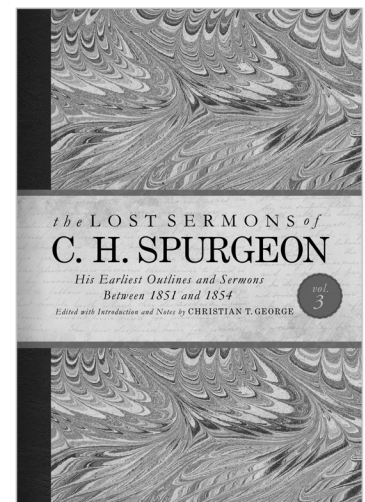

\$59.99

NEW FROM B&H ACADEMIC

COMING SOON!

The Atonement

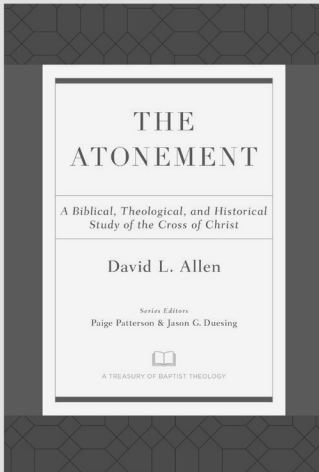

MARCH 2018

American History Vol. 1

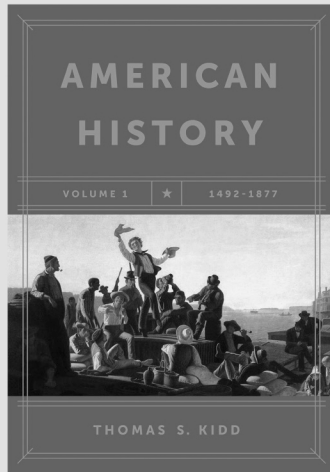

APRIL 2018

American History Vol. 2

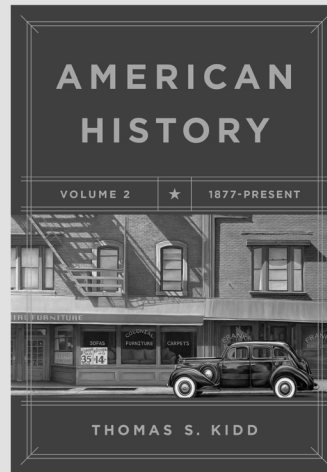

APRIL 2018

Exegetical Guide to the Greek New Testament
2 Corinthians

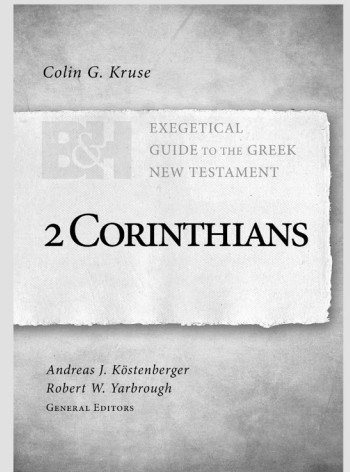

MAY 2017

Preaching for the Rest of Us

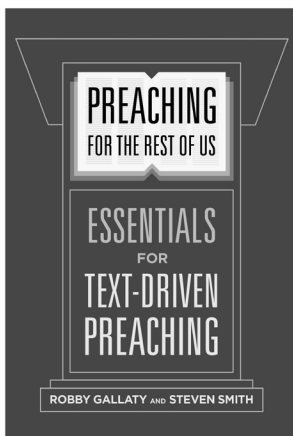

\$19.99

Fuel the Fire

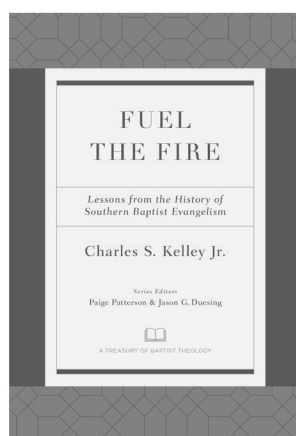

\$29.99

Eschatological Discipleship

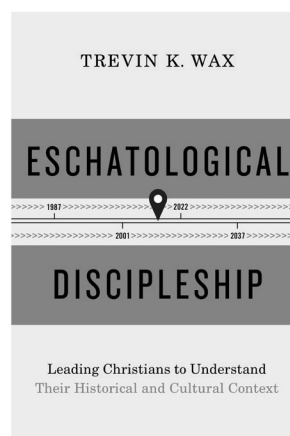

\$29.99

Preaching by the Book

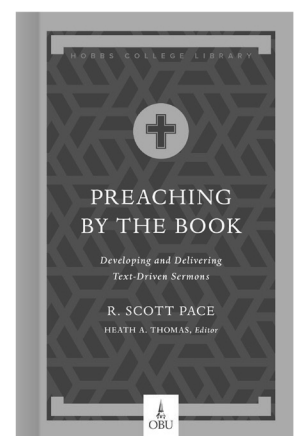

\$14.99



bhacademic.com
bhacademicBLOG.com

See our full catalog at
bhacademic.com/catalog



WORDSEARCH® 12

Equipping preachers and teachers for a lifetime of ministry.

Quickly creat powerful, effective sermons.

Wordsearch 12 is our newest, most advanced desktop tool for creating sermons and personal study. Wordsearch 12 has been updated with new features to provide a streamlined experience and the ability to dive deeper into God's word.

Learn more about new features
included in Wordsearch 12

- Lexicon Explorer
- OneDrive Integration
- Enhanced Sermon Building
- Enhanced Cloud Backup
- Customizable Toolbar

WORDSEARCH® 12

Sheraton Meeting Rooms

Room	Building	Level	Page
Aspen	Tower	Mezzanine	113
Beverly	Tower	Terrace	112
Biltmore	Tower	Terrace	112
Capitol	Tower	Terrace	112
Century	Tower	Mezzanine	113
Colorado	Tower	Mezzanine	113
Columbine	Tower	Terrace	112
Denver	Tower	Mezzanine	113
Director's Row E - J	Plaza	Lobby	111
Exhibit Hall	Plaza	Concourse	110
Gold	Tower	Mezzanine	113
Governor's Square 9 - 17	Plaza	Concourse	110
Grand Ballrooms	Plaza	2nd Floor	113
Majestic	Tower	Majestic	112
Plaza Ballrooms	Plaza	Concourse	110
Plaza Court 6 - 8	Plaza	Concourse	110
Savoy	Tower	Majestic	112
Silver	Tower	Mezzanine	113
Spruce	Tower	Mezzanine	113
Terrace	Tower	Terrace	112
Tower Court A - D	Tower	2nd Floor	113
Vail	Tower	Majestic	112
Windows	Tower	2nd Floor	113

Plaza Building Concourse Level

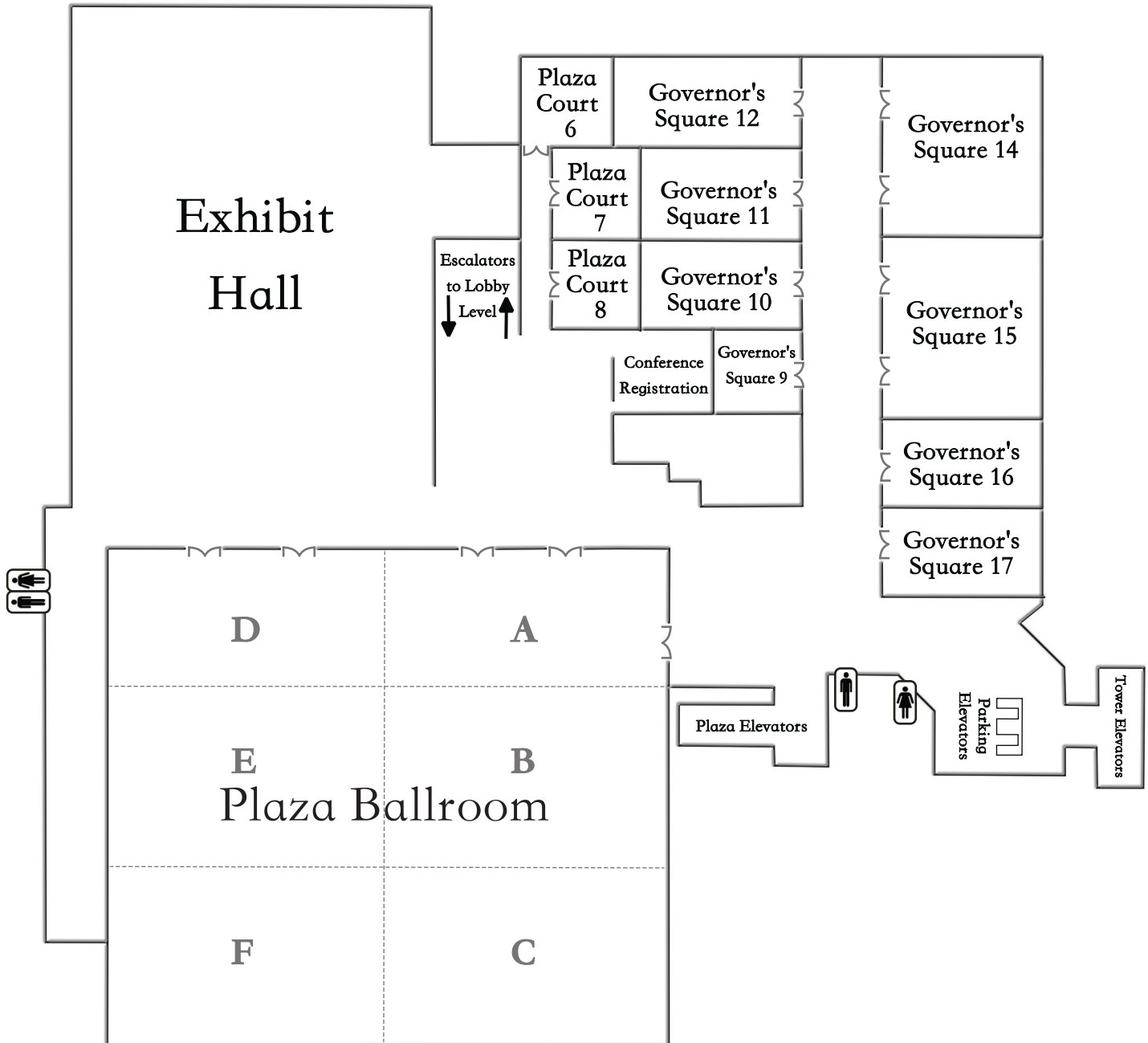

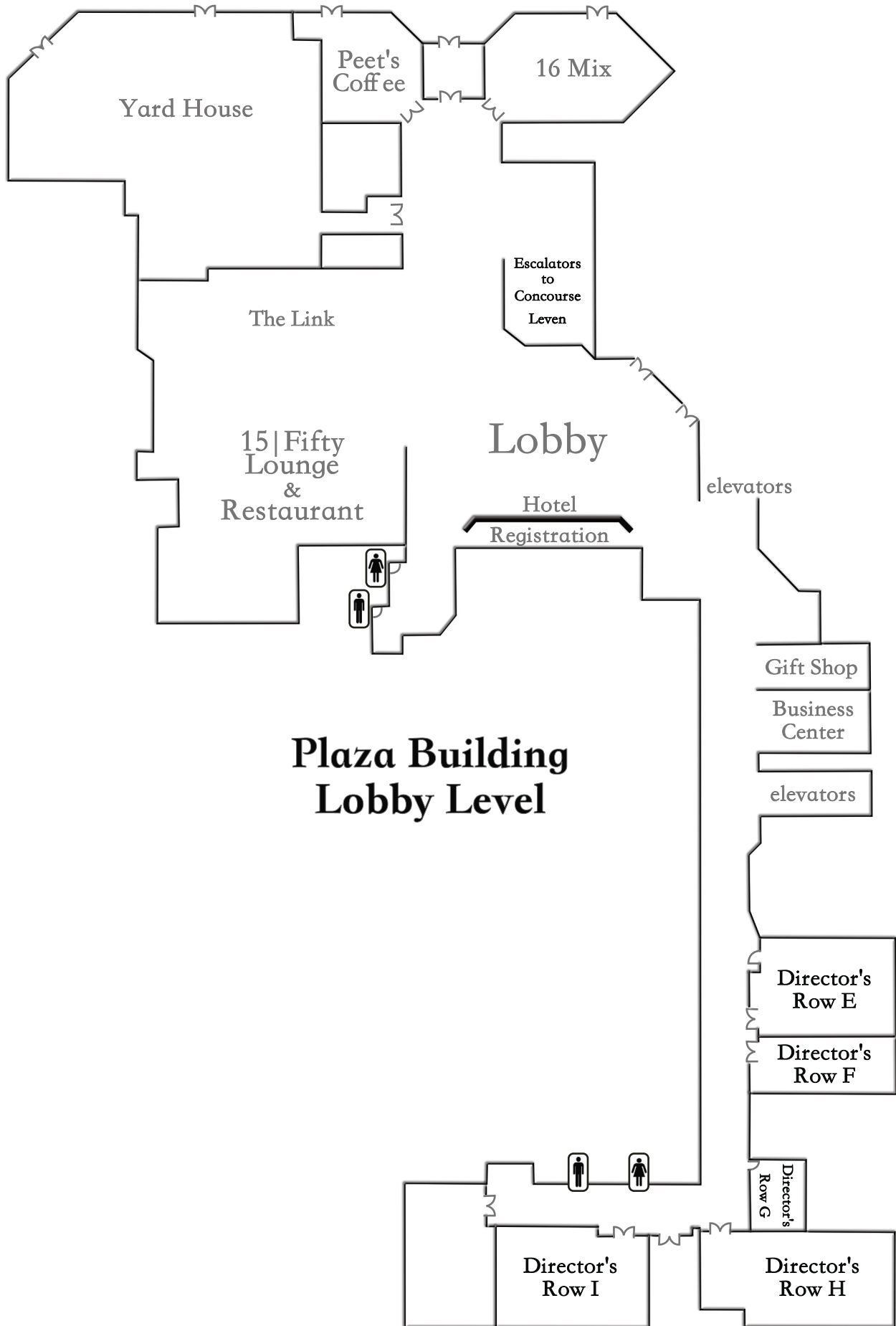

Plaza Building Lobby Level

Tower Building Terrace Level

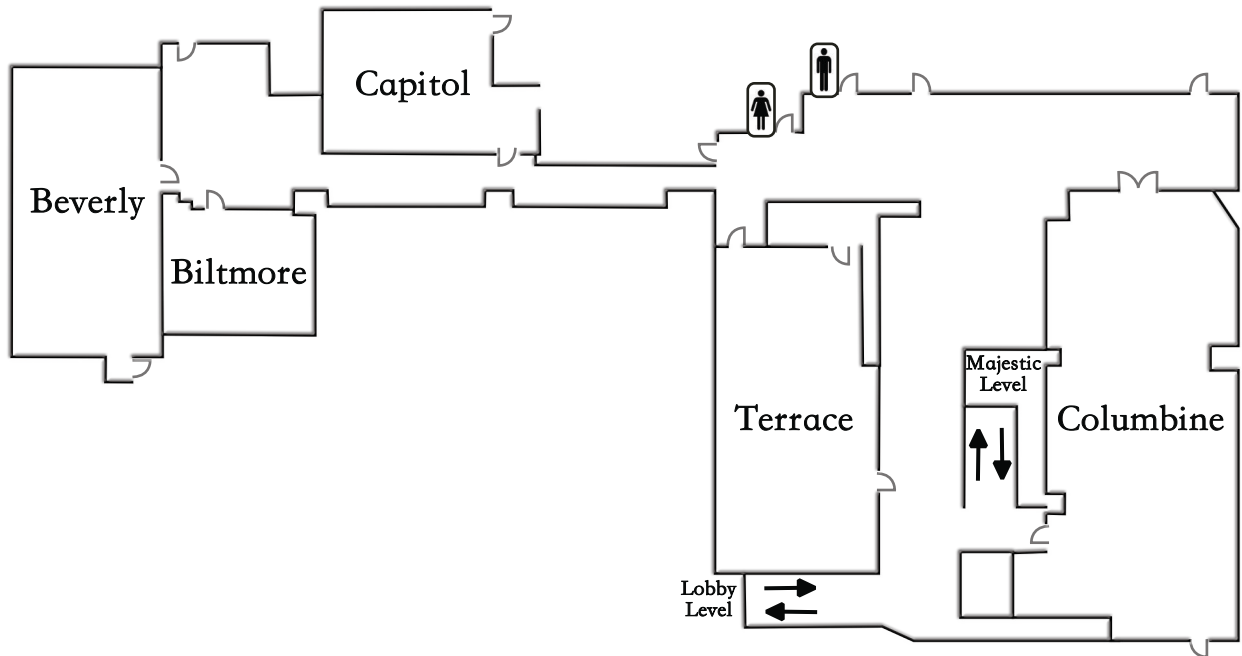

Tower Building Majestic Level

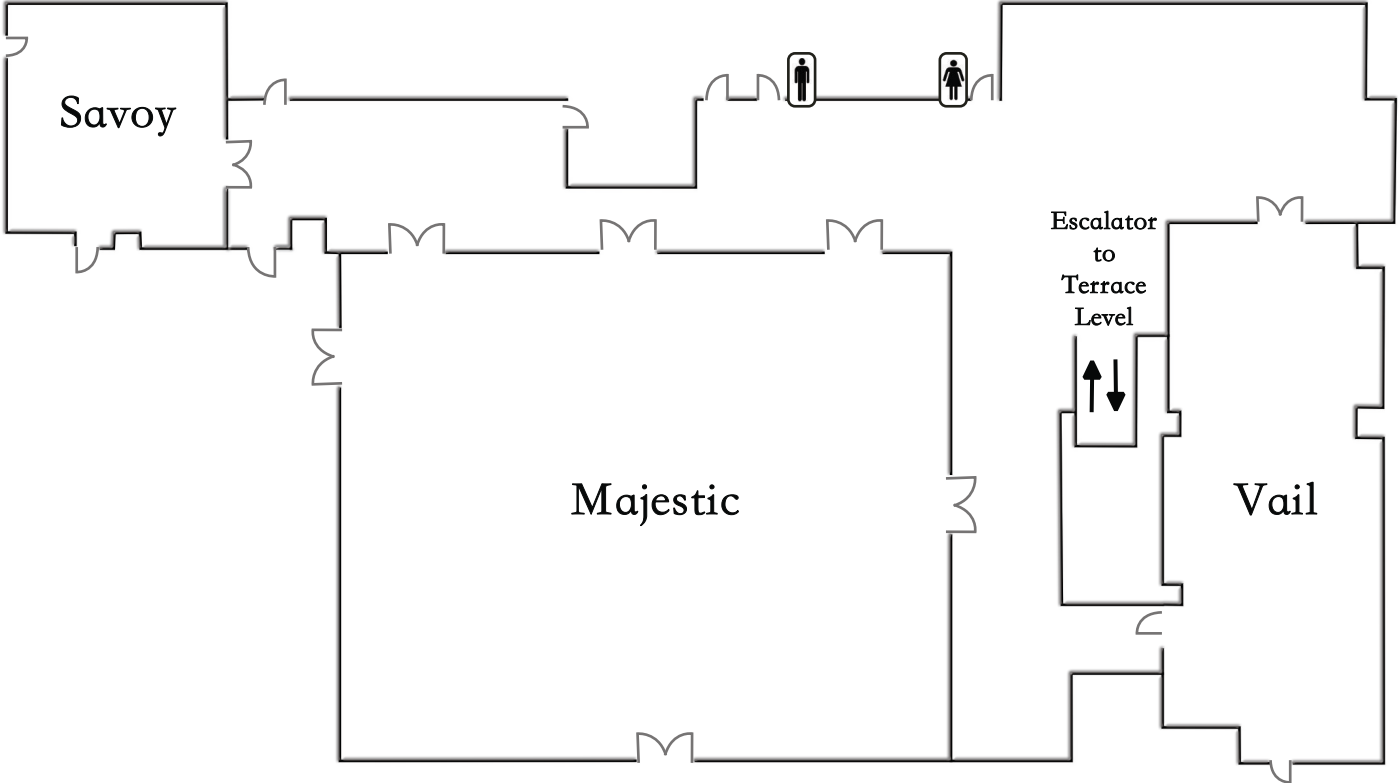

Tower Building Mezzanine Level

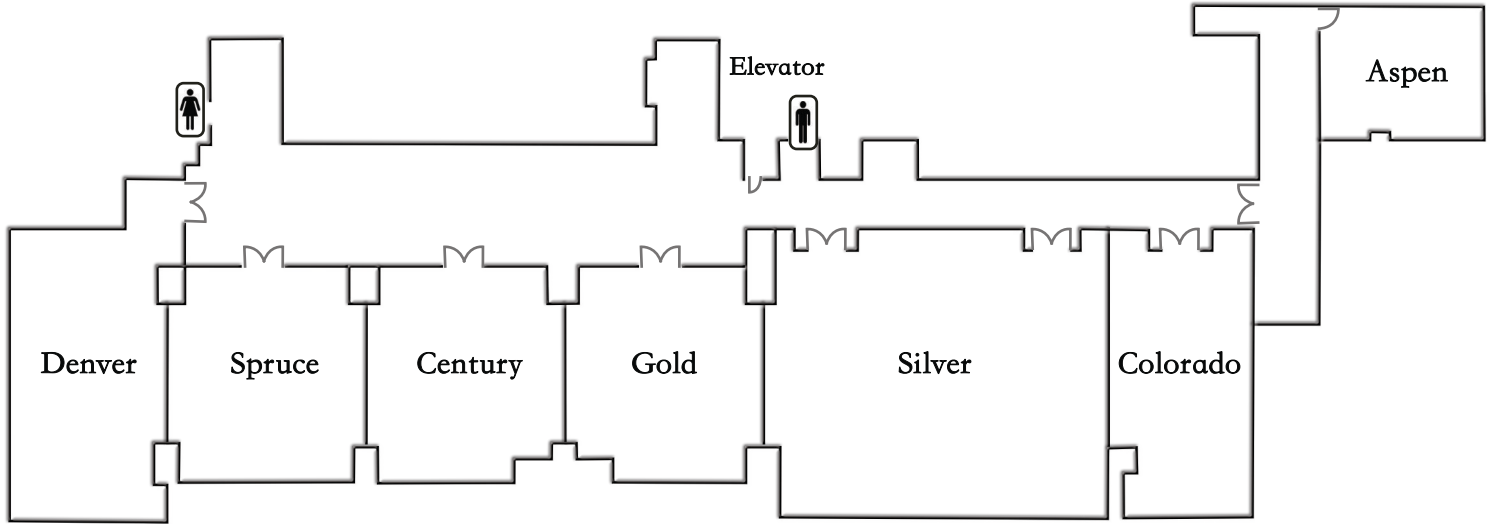

Tower Building 2nd Level

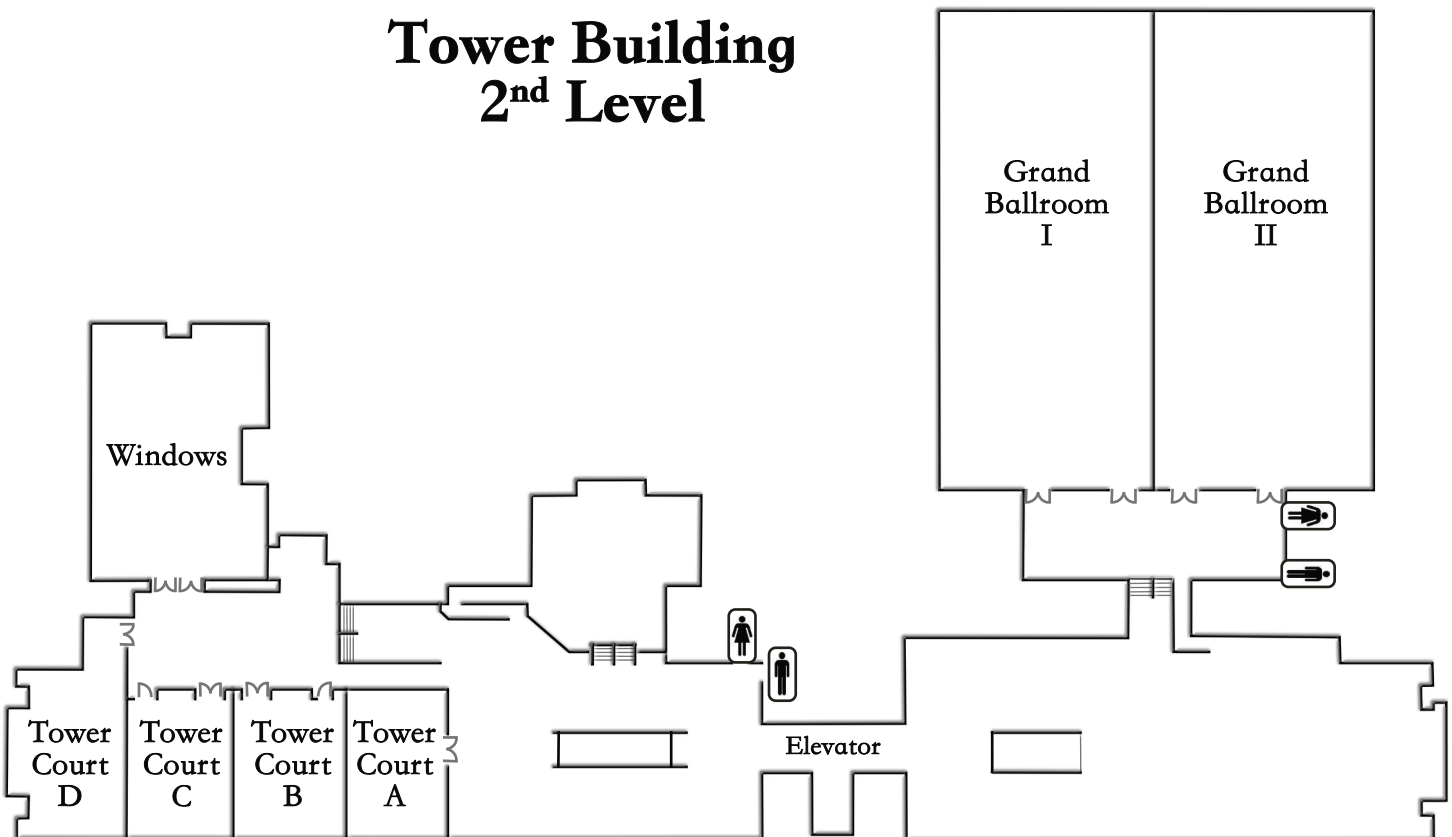

Exhibitors

Booth	Exhibitor	Booth	Exhibitor
508	Abilene Christian Press/Leafwood Publisher	120	Lampion Press
123	Accordance Bible Software	124	Lancaster Bible College / Capital Seminary
411	Adventist Theological Society	311	Langham Partnership
413	Andrews University Press	219	Lexham Press
119	Answers in Genesis	312	Logos Bible Software
112	Association of Certified Biblical Counselors	207	McMaster Divinity College
400	B&H Publishing Group	111	Midwestern Baptist Theological Seminary
101	Baker Academic and Brazos Press	518	Moody Publishers
102	Bible Journey	109	Near East Archaeological Society
306	BibleMesh	309	New Orleans Baptist Theological Seminary
209	Biblical Language Center	224	New Reformation Publications
227	BioLogos	307	Olive Tree Bible Software
108	Calvary University	217	P&R Publishing
213	Chosen People Ministries	104	Ratio Christi
310	Christian Focus Publications	208	Reasons To Believe
122	Christians for Biblical Equality	226	Reformation Heritage Books
512	Colorado Christian University	225	Solid Rock Lectures
113	Concordia Seminary	211	South African Theological Seminary
324	Council on Biblical Manhood and Womanhood	410	Southwestern Baptist Theological Seminary
313	Crossway	215	Training Leaders International
327	Eerdmans Publishing, Co.	216	Tutku Tours
326	Grand Rapids Theological Seminary	212	Tyndale House Publishers, Inc.
415	Hendrickson	210	Wave Study Bible
308	International Preterist Association	514	Westminster John Knox Press
323	IVP Academic	423	Wipf and Stock Publishers
206	Jerusalem University College	107	WordMp3
223	Kregel Academic	201	Zondervan Academic

Exhibit Hall

Plaza Building Concourse Level

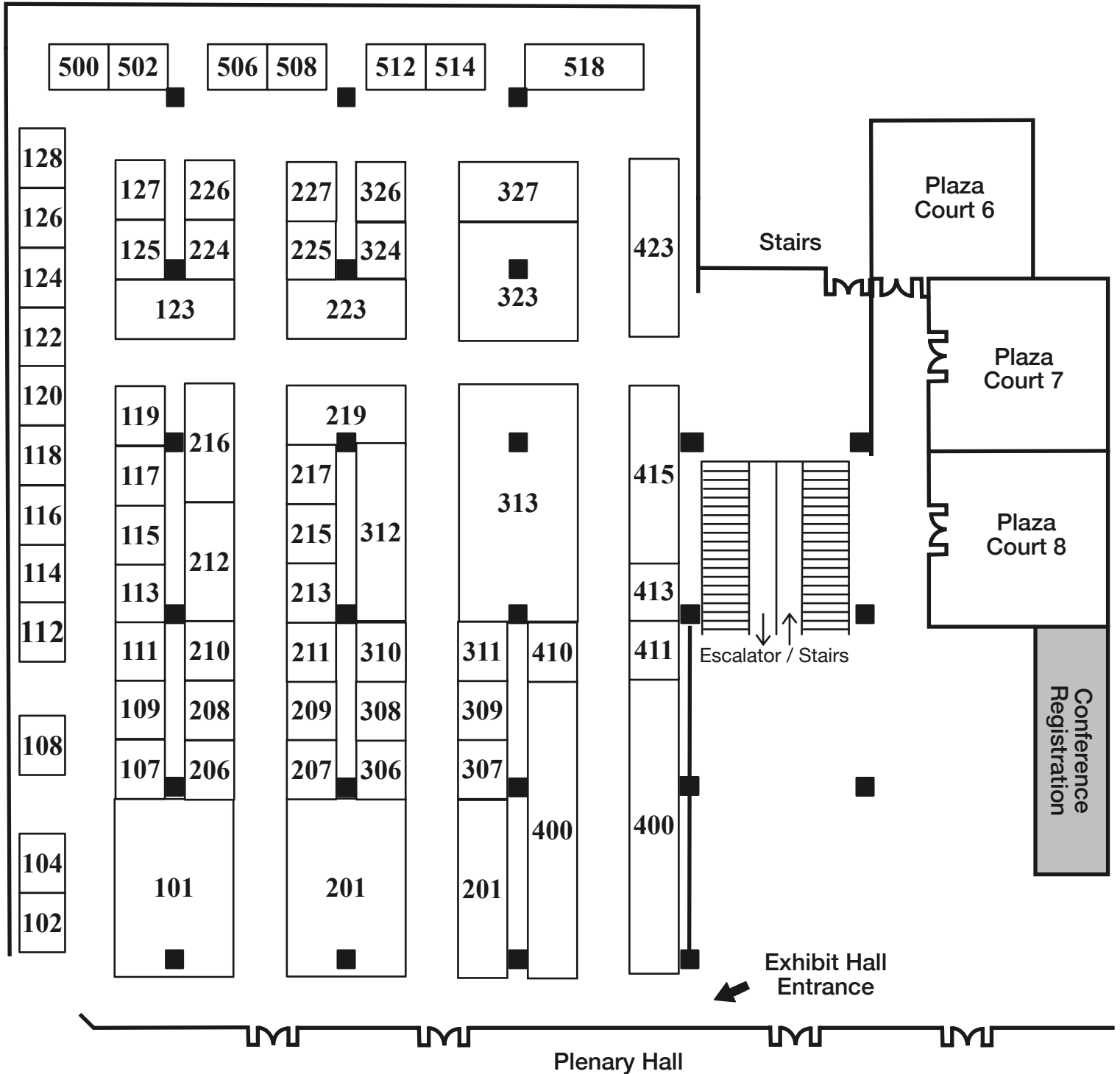

Notes



Conference Registration

70th ETS Annual Meeting

Denver, CO November 13 - 15, 2018

Name: _____ Affiliation: _____
As it should appear on your name badge As it should appear on your name badge

Address: _____

City: _____ State: _____ Zip/Postal Code _____

Email: _____

Spouse Name / Affiliation: _____
If attending conference

Preregistration Prices* (ends Oct 15th)

Student Member** (ETS, EPS, NEAS, or ATS)	\$55
Full or Assoc. Member** (ETS, EPS, NEAS, or ATS)	\$80
Not a Member of ETS, EPS, NEAS, or ATS	\$110

* All prices are USD

**The spouse of a member may be registered at no charge

ETS Annual Meeting Banquet Tickets \$20 each
(Wednesday, November 14th at 7 PM)

Society and Membership Level Registration and Banquet Ticket Totals

- ETS Full or Associate Member
- ETS Student Member
- Evangelical Philosophical Society (EPS) Member
- Near Eastern Archaeological Society (NEAS) Member
- Adventist Theological Society (ATS) Member
- EPS, NEAS or ATS Student Member ***
- Not a Member of any of the above organizations

***EPS, NEAS & ATS Students must register by mail to receive the discounted student rate

Registration \$ _____ USD

Banquet tickets _____ \$ _____ USD

Total \$ _____ USD

Print Program Selection

- Mail** me a printed program
(Only available if registration is received by August 1st)
- Do not mail** me a printed program
I will utilize the app or pdf version of the program

To Pay by Credit Card

Please register online

If you have an ETS username & password go to:
www.etsjets.org/registration_landing

If you do not have an ETS username & password go to: <http://www.etsjets.org/user/register>

ETS does not accept payments by phone, fax, or email

To Pay by Check

Make the check payable to:
Evangelical Theological Society

Mail your check and registration form to:
Evangelical Theological Society
PO Box 776487
Chicago, IL 60677-6487

Registrations and banquet tickets are fully refundable until October 20, 2018
To submit a refund request please go to www.etsjets.org/refund_request_landing

SUBSCRIPTION ORDER FORM



About the Journal

The *Journal of the Evangelical Theological Society* (ISSN 0360-8808) is published four times a year (March, June, September, December). The *Journal* is published by the Evangelical Theological Society. Articles appearing in the *Journal* are regularly indexed by *New Testament Abstracts*, *Christian Periodical Index*, *Religious and Theological Abstracts, Inc.*, *Old Testament Abstracts*, *NEBPI Press*, and *RIC*. Articles are also indexed in *Religion Index One: Periodicals*. Book reviews are indexed in *Index to Book Reviews in Religion*.

About the Society

The purpose of the Evangelical Theological Society is "to foster conservative Biblical scholarship by providing a medium for the oral exchange and written expression of thought and research in the general field of the theological disciplines as centered in the Scriptures" (Constitution, Art. II). The Society and its members affirm that "The Bible alone, and the Bible in its entirety, is the Word of God written and is therefore inerrant in the autographs. God is a Trinity, Father, Son, and Holy Spirit, each an uncreated person, one in essence, equal in power and glory" (Constitution, Art. III).

Subscribing to the Journal

Subscriptions are \$30.00 per year. To subscribe, please submit the form below. (A subscription to *JETS* is included with membership in the Society. For information on becoming a member and receiving the journal as a part of membership, please visit www.etsjets.org.)

Subscribers beginning after April may purchase a partial year subscription (\$7.50 per issue). A partial year subscription may be joined with a full subscription for the following year.

Full Subscription:

Begin with: Next Issue First Issue of Next Year
 One Year \$30.00
 Two Years \$60.00

Partial Year Subscription:

Beginning with: June \$22.50
 September \$15.00
 December \$7.50

Subscriber Information

Name

Address Line 1

Address Line 2

City

State/Province

Zip / Postal Code

Country

Email Address

Make Checks Payable To:

Evangelical Theological Society

Mail Form and Payment To:

Evangelical Theological Society
PO Box 776487
Chicago, IL 60677-6487

MEMBERSHIP APPLICATION



Applicant Information

Name: _____ Date: _____

Address: _____ Phone: _____

City: _____ State: _____ Zip/PC: _____

Country: _____ Email: _____

Membership (check one)

***Member Recommendation Required**

Full (\$30) Associate* (\$30) Student* (\$15) Full Retired (\$15) Associate Retired (\$15)

Have you previously been a member? No Yes Last Year Active: _____

* Sponsoring Member: _____ Email: _____

Present Position: _____

Institution: _____

Church Affiliation: _____ Denomination: _____

Education

Institution: _____

Degree: _____ Date: _____

Institution: _____

Degree: _____ Date: _____

Institution: _____

Degree: _____ Date: _____

Application continued on back - Please complete both sides

APPLICATION CONTINUED

Doctrinal Basis Affirmation

I hereby subscribe to the Society's Doctrinal basis which reads as follows:

The Bible alone, and the Bible in its entirety, is the Word of God written and is therefore inerrant in the autographs. God is a Trinity, Father, Son, and Holy Spirit, each an uncreated person, one in essence, equal in glory and power.

Print Name

* Signature

Date

* Article IV, Section 2 of the Constitution reads: "Every member must subscribe in writing annually to the 'Doctrinal Basis.'" By signing, you are affirming that you hold the Doctrinal Basis of the Evangelical Theological Society to be true.

Payment

Make Checks Payable To:
Evangelical Theological Society

Mail Form and Payment To:
Evangelical Theological Society
PO Box 776487
Chicago, IL 60677-6487